

Accessory modules

Extension modules for IL-NT, IC-NT, IA-NT and ID-Lite

1 Document information	5
2 Table of modules	7
3 Table of symbols	8
4 Modules	9

Table of contents

1 Document information	5
1.1 Clarification of Notation	5
1.2 About this guide	5
1.3 Legal notice	5
2 Table of modules	7
3 Table of symbols	8
4 Modules	9
4.1 I-LB+	10
4.1.1 Description	10
4.1.2 Connectors	11
4.1.3 Address and jumpers settings	11
4.1.4 LEDs indication	14
4.1.5 Wiring	14
4.1.6 Technical data	16
4.2 i-LBA	17
4.2.1 Description	17
4.2.2 Connectors	17
4.2.3 Wiring	18
4.2.4 Technical data	18
4.3 I-RB8/I-RB16/I-RB8-231/I-RB16-231	19
4.3.1 Description	19
4.3.2 Connectors	20
4.3.3 LEDs indication	20
4.3.4 Wiring	20
4.3.5 Technical data	21
4.4 IG-IOM	22
4.4.1 Description	22
4.4.2 Dimensions	22
4.4.3 Terminals	23
4.4.4 Address and jumpers setting	23
4.4.5 LED indication	23
4.4.6 Wiring	24
4.4.7 Technical data	24
4.5 IGS-PTM	26
4.5.1 Description	26

4.5.2 Dimensions	26
4.5.3 Terminals	27
4.5.4 Address and jumpers setting	28
4.5.5 LED indication	30
4.5.6 Wiring	31
4.5.7 Technical data	32
4.6 IG-MTU/IG-MTU-C/MTU-2-1	33
4.6.1 Description	33
4.6.2 Connectors	33
4.6.3 Wiring	33
4.6.4 Dimensions	35
4.6.5 Technical data	35
4.7 IL-NT-AOUT8	36
4.7.1 Description	36
4.7.2 Connectors	36
4.7.3 Wiring	37
4.7.4 Technical data	38
4.8 IL-NT-RS232	39
4.8.1 Description	39
4.8.2 Connectors	39
4.8.3 Wiring	40
4.8.4 Technical data	40
4.9 IL-NT-S-USB	41
4.9.1 Description	41
4.9.2 Connectors	41
4.9.3 LED Indications	42
4.9.4 Wiring	42
4.9.5 Technical data	42
4.10 IL-NT-FCM	43
4.10.1 Description	43
4.10.2 Connectors	43
4.10.3 Address and jumper setting	43
4.10.4 Others information	44
4.10.5 Wiring	45
4.10.6 Technical data	45
4.11 IL-NT-RS232-485	46
4.11.1 Description	46
4.11.2 Connectors	46
4.11.3 Wiring	47

4.11.4 Technical data	47
4.12 IL-NT-BIO8	48
4.12.1 Description	48
4.12.2 Connectors	48
4.12.3 Address and jumper setting	48
4.12.4 Others information	49
4.12.5 Wiring	49
4.12.6 Technical data	50
4.13 IC-NT-CT-BIO7	51
4.13.1 Description	51
4.13.2 Connectors	51
4.13.3 Address and jumper setting	51
4.13.4 Others information	51
4.13.5 Wiring	54
4.13.6 Technical data	55
4.14 IL-NT-IO1	56
4.15 IL-NT-AIO	57
4.16 Inteli RPU	58
4.16.1 Installation and wiring	59
4.16.2 Features	62
4.16.3 Overspeed RPM configuration	63

1 Document information

1.1 Clarification of Notation	5
1.2 About this guide	5
1.3 Legal notice	5

1.1 Clarification of Notation

Note: This type of paragraph calls the reader's attention to a notice or related theme.

IMPORTANT: This type of paragraph highlights a procedure, adjustment etc., which can cause a damage or improper function of the equipment if not performed correctly and may not be clear at first sight.

WARNING: This type of paragraph highlights a procedure, adjustment etc., which can cause a damage or improper function of the equipment if not performed correctly and may not be clear at first sight.

Example: This type of paragraph contains information that is used to illustrate how a specific function works.

1.2 About this guide

This guide contains information about extension modules for IL-NT, IC-NT, IA-NT and ID-Lite.

1.3 Legal notice

This End User's Guide/Manual as part of the Documentation is an inseparable part of ComAp's Product and may be used exclusively according to the conditions defined in the "END USER or Distributor LICENSE AGREEMENT CONDITIONS – COMAP CONTROL SYSTEMS SOFTWARE" (License Agreement) and/or in the "ComAp a.s. Global terms and conditions for sale of Products and provision of Services" (Terms) and/or in the "Standardní podmínky projektů komplexního řešení ke smlouvě o dílo, Standard Conditions for Supply of Complete Solutions" (Conditions) as applicable.

ComAp's License Agreement is governed by the Czech Civil Code 89/2012 Col., by the Authorship Act 121/2000 Col., by international treaties and by other relevant legal documents regulating protection of the intellectual properties (TRIPS).

The End User and/or ComAp's Distributor shall only be permitted to use this End User's Guide/Manual with ComAp Control System Registered Products. The Documentation is not intended and applicable for any other purpose.

Official version of the ComAp's End User's Guide/Manual is the version published in English. ComAp reserves the right to update this End User's Guide/Manual at any time. ComAp does not assume any responsibility for its use outside of the scope of the Terms or the Conditions and the License Agreement.

Licensed End User is entitled to make only necessary number of copies of the End User's Guide/Manual. Any translation of this End User's Guide/Manual without the prior written consent of ComAp is expressly prohibited!

Even if the prior written consent from ComAp is acquired, ComAp does not take any responsibility for the content, trustworthiness and quality of any such translation. ComAp will deem a translation equal to this End

User's Guide/Manual only if it agrees to verify such translation. The terms and conditions of such verification must be agreed in the written form and in advance.

For more details relating to the Ownership, Extent of Permitted Reproductions Term of Use of the Documentation and to the Confidentiality rules please review and comply with the ComAp's License Agreement, Terms and Conditions available on www.comap-control.com.

Security Risk Disclaimer

Pay attention to the following recommendations and measures to increase the level of security of ComAp products and services.

Please note that possible cyber-attacks cannot be fully avoided by the below mentioned recommendations and set of measures already performed by ComAp, but by following them the cyber-attacks can be considerably reduced and thereby to reduce the risk of damage. ComAp does not take any responsibility for the actions of persons responsible for cyber-attacks, nor for any damage caused by the cyber-attack. However, ComAp is prepared to provide technical support to resolve problems arising from such actions, including but not limited to restoring settings prior to the cyber-attacks, backing up data, recommending other preventive measures against any further attacks.

Warning: Some forms of technical support may be provided against payment. There is no legal or factual entitlement for technical services provided in connection to resolving problems arising from cyber-attack or other unauthorized accesses to ComAp's Products or Services.

General security recommendations and set of measures

1. AccessCode

- Change the AccessCode BEFORE the device is connected to a network.
- Use a secure AccessCode – ideally a random string of 8 characters containing lowercase, uppercase letters and digits.
- For each device use a different AccessCode.

2. Password

- Change the password BEFORE the device enters a regular operation.
- Do not leave displays or PC tools unattended if an user, especially administrator, is logged in.

3. Controller Web interface

- The controller web interface at port TCP/80 is based on http, not https, and thus it is intended to be used only in closed private network infrastructures.
- Avoid exposing the port TCP/80 to the public Internet.

4. MODBUS/TCP

- The MODBUS/TCP protocol (port TCP/502) is an instrumentation protocol designed to exchange data between locally connected devices like sensors, I/O modules, controllers etc. From it's nature it does not contain any kind of security – neither encryption nor authentication. Thus it is intended to be used only in closed private network infrastructures.
- Avoid exposing the port TCP/502 to the public Internet.

5. SNMP

- The SNMP protocol (port UDP/161) version 1,2 is not encrypted. Thus it is intended to be used only in closed private network infrastructures.
- Avoid exposing the port UDP/161 to the public Internet.

2 Table of modules

Module	Controller type				Related documentation
	IL-NT	IC-NT	ID-Lite	IA-NT	
I-LB/I-LB+	✗	✓	✗	✗	
I-LBA	✓	✓	✓	✓	
I-RB8	✓	✓	✓	✗	
I-RB8-231	✓	✓	✓	✗	
IG-IB	✓	✓	✓	✗	IG-6.1-IS-3.1-CommunicationGuide
IG-IOM	✓ #	✓	✗	✗	
IGL-RA15	✓ #	✓	✓	✗	IGL-RA15-1.2
IG-MTU/IG-MTU-C/MTU-2-1	✓	✓	✓	✗	
IGS-PTM	✓ #	✓	✗	✗	
IL-NT AOUT8	✓	✓	✓	✗	
IL-NT RS232	✓	✓	✓	✓	
IL-NT S-USB	✓	✓	✓	✓	
IL-NT BIO8	✓	✓	✓	✓	
IC-NT-CT-BIO7	✗	✓	✗	✗	
IL-NT IO1	✗	✗	✓	✗	
IL-NT AIO	✗	✗	✓	✗	
IL-NT FCM	✓ *	✗	✗	✗	
IL-NT RS232-485	✓	✓	✓	✓	
IC-NT RD	✗	✓	✗	✗	IC-NT-RD-1.0-New Features















Note:





IL only MRS15, MRS16, AMF25

* only IntelLog

Note: For connecting with controller and unit reprogramming, see **Proprietary controller guide**.

3 Table of symbols

Icon	Description
	Supported IntelliDrive controller
	Supported IntelliSys-NT controller
	Supported IntelliGen-NT controller
	Supported IntelliGen-NT controller
	Supported IntelliGen-NT and IntelliSys-NT controller
	Supported CAN1 line
	Supported CAN2 line
	Supported CAN1 and CAN2 line
	Supported USB
	Supported Ethernet
	Supported RS232 line
	Supported RS485 line
	Module has analog inputs
	Module has digital inputs

	Module has analog output
	Module has digital output
	Unit is 35 mm DIN rail mounted
	Unit is direct to controller mounted

[⬅ back to Table of contents](#)

4 Modules

4.1 I-LB+	10
4.2 i-LBA	17
4.3 I-RB8/I-RB16/I-RB8-231/I-RB16-231	19
4.4 IG-IOM	22
4.5 IGS-PTM	26
4.6 IG-MTU/IG-MTU-C/MTU-2-1	33
4.7 IL-NT-AOUT8	36
4.8 IL-NT-RS232	39
4.9 IL-NT-S-USB	41
4.10 IL-NT-FCM	43
4.11 IL-NT-RS232-485	46
4.12 IL-NT-BIO8	48
4.13 IC-NT-CT-BIO7	51
4.14 IL-NT-IO1	56
4.15 IL-NT-AIO	57
4.16 Intel RPU	58

 [back to Table of contents](#)

4.1 I-LB+



4.1.1 Description

I-LB+ is communication modules for communication with all devices connected to CAN2 bus. I-LB+ is successors of the IG-MU unit designed to be used with classic controllers. It therefore provides additional communication port and higher communication speed. Speed for direct/modem connection can be up to 57600 bps (IG-MU only 19200 bps). I-LB/I-LB+ can be connected with PC via USB, RS232 or RS485. I-LB is without USB port, I-LB+ is with USB port (speed \approx 115200 bps).

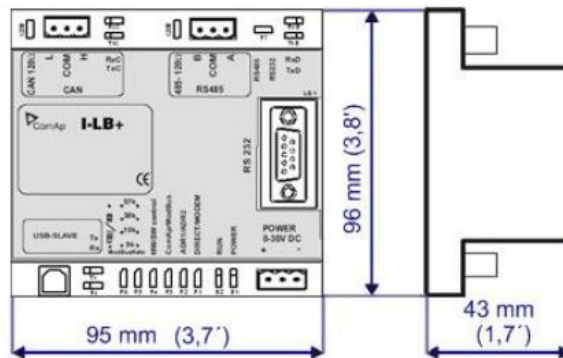

Unit is 35 mm DIN rail mounted.

4.1.2 Connectors

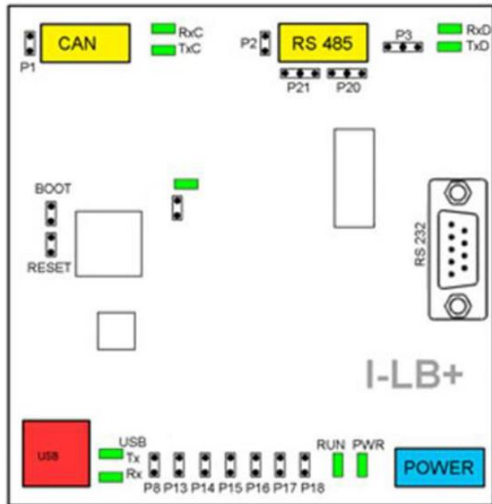

POWER	Power supply
CAN	CAN 1 line
USB	USB line
RS232	RS485 line
J13 - J18	SW/HW control
BOOT	Programming
RESET	Programming/Reset
P1	Terminating resistor
P2	Terminating resistor
P3	RS232 or RS485
P8	USB enable/disable
P13	Communication speed
P14	Communication speed
P15	Modem control (HW/SW)
P16	Protocol (Modbus/ComAp)
P17	CAN address
P18	Connection (direct/modem)
P20	Bias -A
P21	Bias -B
RxC, TxC	CAN data
RxD, TxD	RSxxx data
Tx, Rx USB	USB data
RUN	Power
PWR	Module state

4.1.3 Address and jumpers settings

CAN1 termination (P1)

I-LB+ has included CAN terminating resistor (120 ohm). Close jumper P1 to connect terminating resistor to CAN bus, open jumper P1 to disconnect terminating resistor.

RS232 or RS485 termination (P2)

I-LB+ has included RS232/RS485 terminating resistor (120 ohm). Close jumper P2 to connect terminating resistor to RS485 bus, open jumper P2 to disconnect terminating resistor.

Select RS mode (P3)

Jumper P3 selecting RS mode. When jumper P3 is connected to 1-2, RS232 mode is activated. When jumper P3 is connected to 2-3, RS485 mode is active.

ComAp / Modbus (P16)

Jumper P16 selects between ComAp PC tools (InteliMonitor, WinScope, et al.) and third party PC SW for monitoring with Modbus interface. ComAp PC tools are selected when P16 is opened; Modbus is selected when P16 is closed.

Modbus rate (P13 and P14)

Modbus rate is set by jumpers P13 and P14; description is in the table bellow.

Modbus rate	P13	P14
9600 bps	Open	Open
19200 bps	Close	Open
38400 bps	Open	Close
57600 bps	Close	Close

Direct/Modem (P18)

Select between direct connection via RS232 or RS 485 and modem connection type. For modem connection is jumper P18 closed, for direct connection is jumper P18 opened.

ADR1 / ADR2 (P17)

Select device address. ADR1 is selected if P17 is opened and ADR2 is selected if P17 is closed.

SW/HW control (P15)

Select SW or HW modem control. Jumper P15 is opened for HW modem control and closed for SW modem control.

RS485 bias resistor (P20 and P21)

Jumpers P20 and P21 are opened if the bias resistors (560R) are not requested. Closed jumper connects bias resistor to the line A (P20) or B (P21).

USB interface enable/disable (P8) (missing on HW 1.0)

Jumper P8 has to be set to enable USB interface. Opened jumper disables USB interface (disabled USB doesn't occupies a communication channel on the CAN bus i.e. there are still 3 free communications channels on the CAN bus).

USB interface allows only local communication (modbus is not implemented in this interface!).

Jumper	Description	State
P1	CAN terminating resistor	Opened – not connect
P2	RS485 terminating resistor	Opened – not connect
P3	RS232 or RS485	1–2 – active RS232
P8	USB enable/disable	Opened – disabled
P13	Modbus rate	Opened
P14	Modbus rate	Opened – 9600 bps
P15	HW or SW modem control	Opened – HW control
P16	ComAp or Modbus	Opened – ComAp protoco
P17	ADR1 or ADR2	Opened – ADR1
P18	Direct or Modem	Opened – Direct

Jumper tree

- ComAp
 - DIRECT
 - RS232/RS485 – selection of serial communication type
 - ADR1/ADR2 – selection between two available local communication channels
 - MODEM
 - HW/SW control – selection between modems with full interface
 - ADR1/ADR2 – selection between two available modem communication channels; IG/IS-NT controllers only
 - Setting RS232/RS485 jumper to RS232 position is obligatory
- Modbus (not available at USB port of I-LB+, USB port always works in ComAp mode)
 - DIRECT
 - RS232/RS485 – selection of serial communication type
 - ADR1/ADR2 – selection between two available local communication channels
 - MODEM
 - ADR1/ADR2 – selection between two available modem communication channels; IG/IS-NT controllers only,
 - Setting HW/SW control has no influence; a modem with HW control is always expected in this mode

Programming

For programming is necessary to close BOOT jumper. RESET jumper is used to reset the device. Close jumper to reset the device. For programming is used FlashProg PC tool. Check if jumper P3 is set according to your communication interface (mostly RS232 – position 1-2).

4.1.4 LEDs indication

LED	Description	State
RxC	No data are received on the CAN line	Dark
	Data are received on the CAN line	Blink
TxC	No data are transmitted on the CAN line	Dark
	Data are transmitted on the CAN line	Blink
RxD	No data are received on the RS232 or RS485 line	Dark
	Data are received on the RS232 or RS485 line	Blink
TxD	No data are transmitted on the RS232 or RS485 line	Dark
	Data are transmitted on the RS232 or RS485 line	Blink
TxUSB	No data are received on USB	Dark
	Data are received on USB	Blink
RxUSB	No data are transmitted on USB	Dark
	Data are transmitted on USB	Blink
RUN	No power supply	Dark
	Power supply OK	Continuous light
PWR	When at least one controller is active on the CAN bus	Continuous light
	After connection power supply - no controller detected on the CAN bus (during communication speed detection).	Blink

4.1.5 Wiring

I-LB+ has to be connected to modem via standard modem cable (full RS232) where the DSR (Data Set Ready) signal detects modem presence (when MODEM (HW) type selected). Three-wire RS232 cable (TxD, RxD, GND) can be used (e.g. for GSM modems) when MODEM (SW) type is selected.

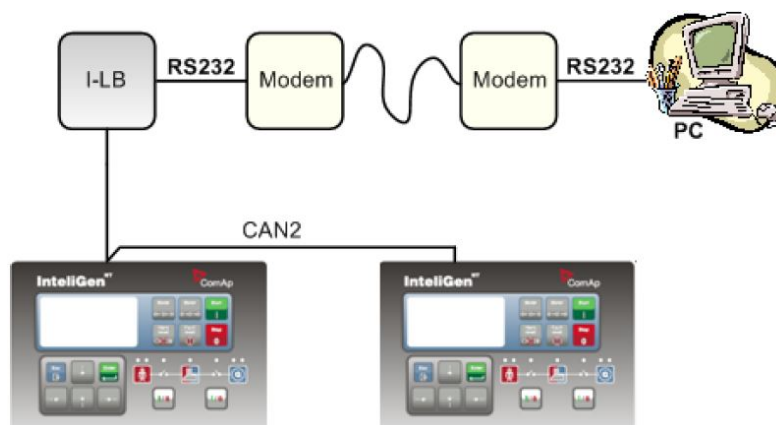

Combined communication – remote and modem

> Option 1:

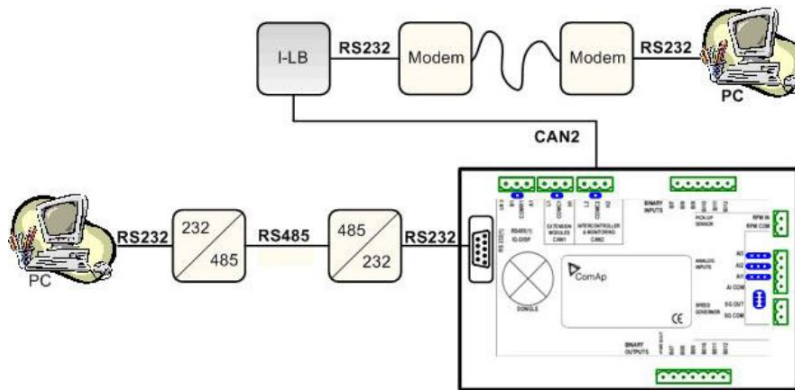

> Option 2:

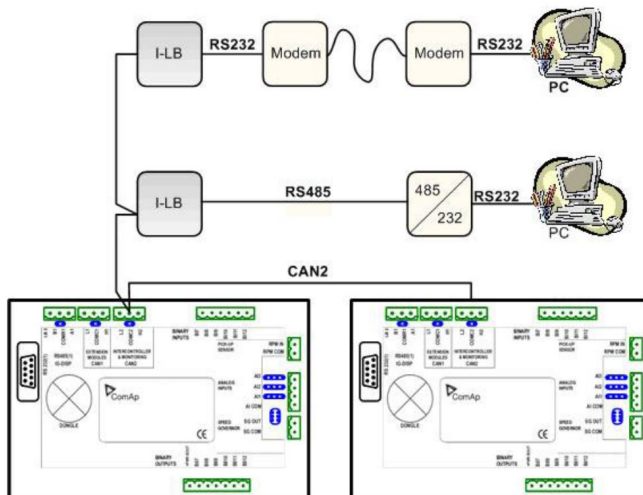

Combined communication I-LB+ with maximum configuration

There are more separate internal channels for NT controller connection which can operate at once (all via CAN2):

- > Local connection 1 (I-LB+ local address 1)
- > Local connection 2 (I-LB+ local address 2)
- > Modem connection 1 (I-LB+ modem address 1)
- > Modem connection 2 (I-LB+ modem address 2)

It is necessary to select which connection type(s) particular I-LB+ is using.

Available combinations of I-LB+ modules

There are four of communication channels available on the CAN2 link at the same time.

I-LB+ module	DIRECT/MODEM jumper	ADR1/ADR2 jumper	channel 1 (local con. 1)	channel 2 (local con. 2)	channel 3 (modem con. 1)	channel 4 (***) (modem con. 2)
<i>Connection possibilities of only I-LB+ in following eight examples</i>						
1.	I-LB+ (*)	DIRECT	ADR1	RS232/485	-	-
2.	I-LB+ (*)	DIRECT	ADR2	-	RS232/485	-
3.	I-LB+ (*)	MODEM	ADR1	-	-	RS232-modem
4.	I-LB+ (*)	MODEM	ADR2	-	-	RS232-modem
5.	I-LB+	DIRECT	ADR1	RS232/485	USB	-
6.	I-LB+	DIRECT	ADR2	USB	RS232/485	-
7.	I-LB+	MODEM	ADR1	-	USB	RS232-modem
8.	I-LB+	MODEM	ADR2	USB	-	RS232-modem
<i>Connection possibilities of both I-LB+ (**) in following four examples</i>						
9.	I-LB+ (*)	DIRECT	ADR1	RS232/485	-	-
	I-LB+	MODEM	ADR1	-	USB	RS232-modem
10.	I-LB+ (*)	MODEM	ADR1	-	-	RS232-modem
	I-LB+	DIRECT	ADR1	RS232/485	USB	-
11.	I-LB+ (*)	MODEM	ADR1	-	-	RS232-modem
	I-LB+	MODEM	ADR2	USB	-	RS232-modem
12.	I-LB+	MODEM	ADR1	-	USB	RS232-modem
	I-LB+	MODEM	ADR2	USB	-	RS232-modem

(*) – USB interface is disabled

(**) – there can be max. two of I-LB+ on the CAN2 link.

(***) – available for IG-NT, IS-NT controllers only, not for ID, IG, IS, IL-NT

Modbus communication via I-LB+

To use I-LB+ modbus communication connect Modbus jumper in I-LB+ unit. Additionally, you can choose the communication speed using the speed selection jumpers. Their combination allows the speed selection of 9600/19200/38400/57600 bps. Modbus is not supported via USB interface.

4.1.6 Technical data

Dimension (W×H×D)	95×96×43 mm (3.7'×3.8'×1.7')
Interface to controller	CAN
Interface to modem or PC	RS232, RS422, RS485, USB only I-LB+
Power supply	8 to 36 V DC
Analog outputs refreshment	Max. 300 ms
Current consumption	100mA at 24 V
Storage temperature	- 40 °C to + 80 °C
Operating temperature	- 30 °C to + 70 °C

🔍 back to I-LB+

4.2 i-LBA



4.2.1 Description

For the connections with 12VDC power supply an i-LBA module can be connected to controller power terminals in order to allow the controller to continue operation during cranking if the battery voltage dip occurs.

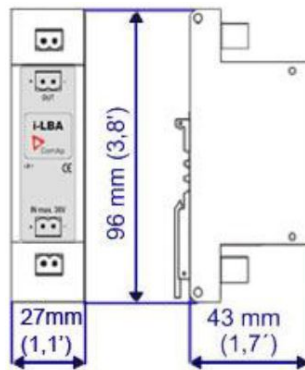

Note: Unit is 35 mm DIN rail mounted.

4.2.2 Connectors



POWER in	Power supply from battery
POWER out	Power supply to controller

4.2.3 Wiring

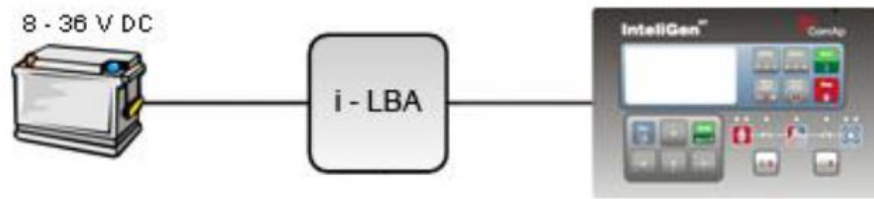

4.2.4 Technical data

Dimension (W×H×D)	27×96×43 mm (1.1'×3.8'×1.7')
Outputs	8 to 36 V DC, no galvanic separation
Internal resistance	Under 0.2 ohm
Power supply	8 to 36 V DC
Storage temperature	- 40 °C to + 80 °C
Operating temperature	- 30 °C to + 70 °C

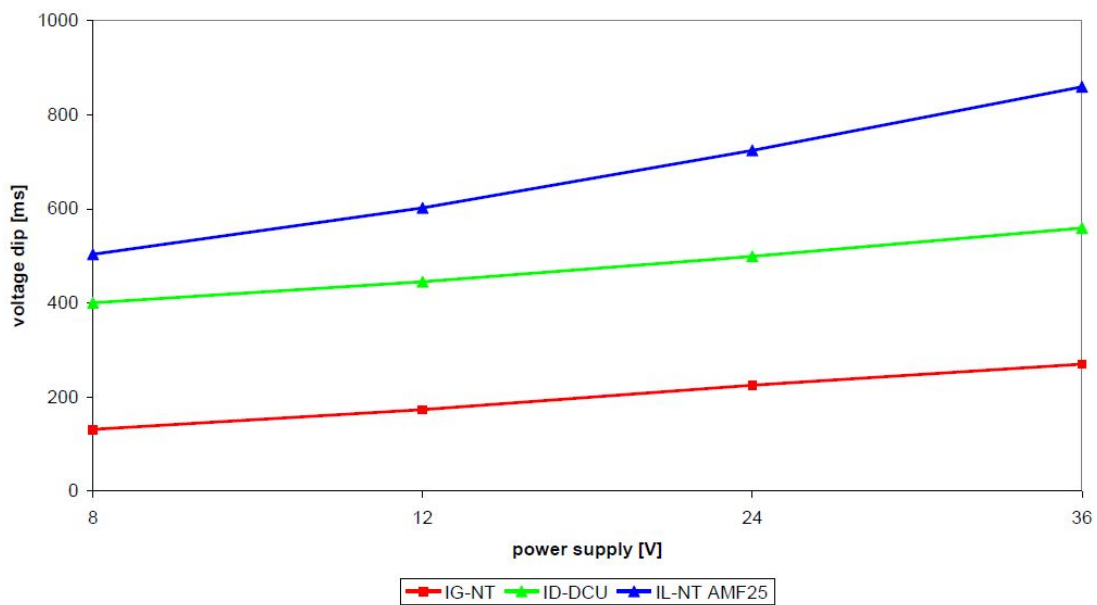

Image 4.1 Voltage dip recovery

[back to i-LBA](#)

4.3 I-RB8/I-RB16/I-RB8-231/I-RB16-231



4.3.1 Description

Relay board contains 8 or 16 relays for binary (open collector) output separation. All relays are placed in sockets.

	I-RB8	I-RB16	I-RB8-231	I-RB16-231
Number of relays	8	16	8	16
Nominal voltage [V] DC	24	24	230	230
Maximal load	16A resistive load, 4A inductive load			

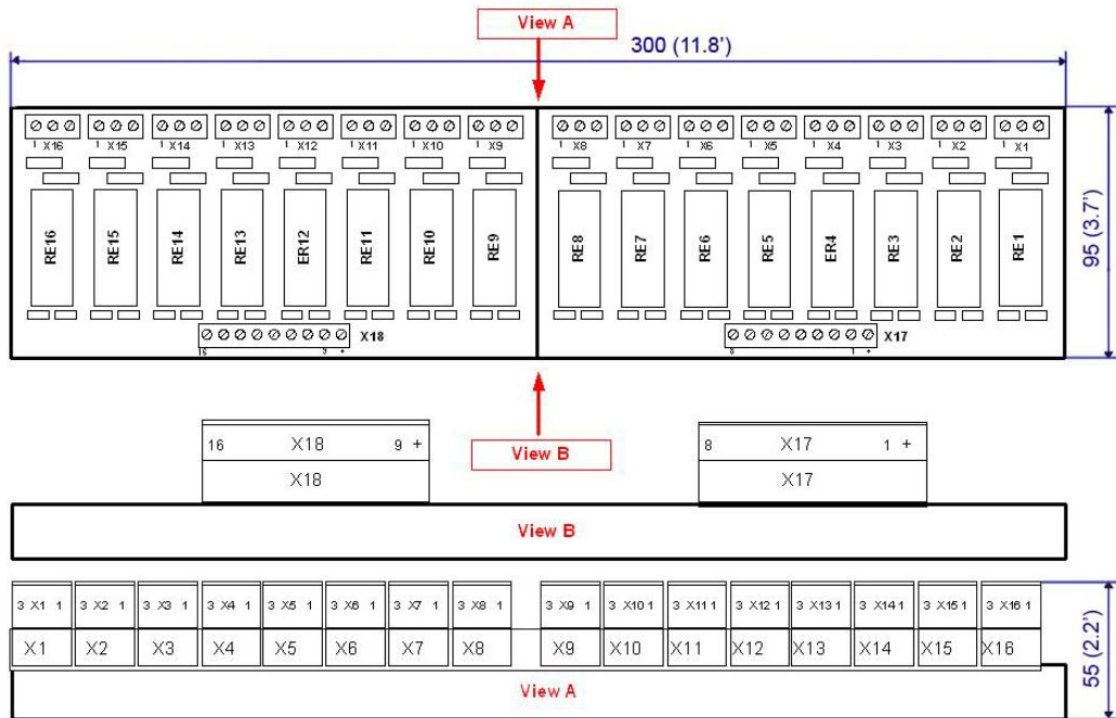

Image 4.2 Unit is 35 mm DIN rail mounted.

4.3.2 Connectors



O1-O16	Relay connector
INPUT1 INPUT2	Input signals

4.3.3 LEDs indication

Each relay has LED which lights when n.o. relay's connector is closed. This LED is dark when n.o. relay's connector is open. I-RB8, I-RB8-231 has 8 LEDs and I-RB16, I-RB16-231 has 16 LEDs.

4.3.4 Wiring

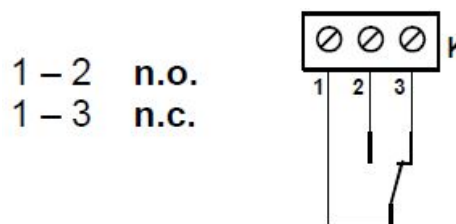



Image 4.3 Relay-connector connection

4.3.5 Technical data

Dimension (W×H×D)	300×95×55 mm (11.8'×7.7'×2.2')
Outputs	Max. switched current 16A DC, 4A AC Max. switched voltage 24V DC, 230V AC*
Voltage range	16.8 – 36V DC
Relay opens	At 10% of nominal voltage
Electric/mechanic cycles	100 000 (when switching 16A) / 10 000 000
Contacts protection	varistor 14DK390
Storage temperature	- 40 °C to + 80 °C
Operating temperature	30 °C to + 70 °C

Note:

* - only I-RB8-231, IRB-16-231

 [back to I-RB8/I-RB16/I-RB8-231/I-RB16-231](#)

4.4 IG-IOM



4.4.1 Description

IG-IOM modules are I/O extension modules equipped with 8 binary inputs, 8 binary outputs, 4 analog inputs and one analog output. The module can be used for only MRS15/16 and AMF 25 from IL-NT family.

- Binary inputs and outputs are configurable the same way like inputs and outputs on controller.
- The protection of analog IOM inputs is activated by overcrossing the limits, active only when the engine is running.
- IG-IOM analog inputs are resistive (the same parameters like controller) 0 Ω-2,4 kΩ. The module IOM is designed for especially VDO resistive sensors.

4.4.2 Dimensions

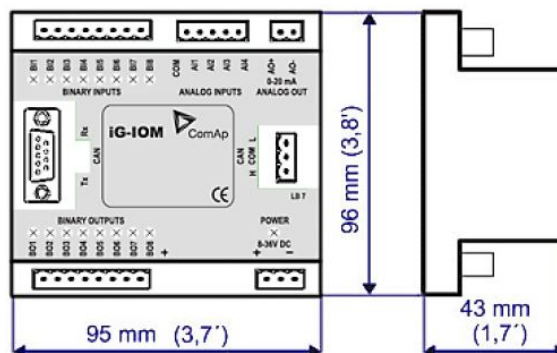

Note: Unit is 35 mm DIN rail mounted.

4.4.3 Terminals

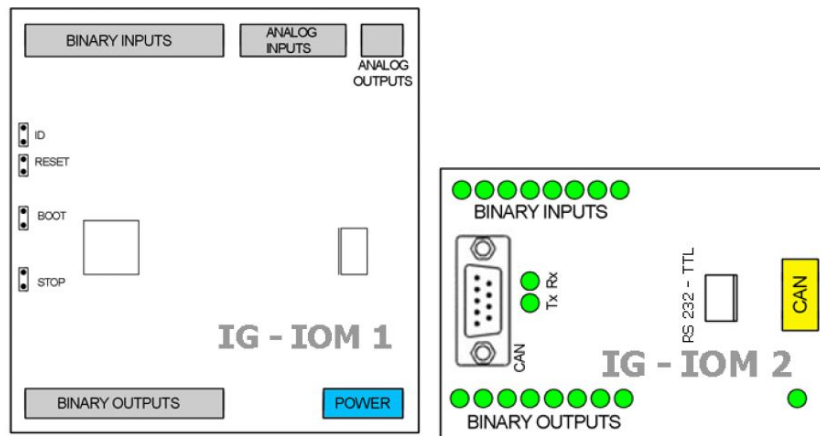

BINARY INPUTS	8 binary input
ANALOG INPUTS	4 analog input
ANALOG OUTPUTS	1 analog output
BINARY OUTPUTS	8 binary output
CAN	CAN1 line
RS232-TTL	Interface for programming
POWER	Power supply
BINARY INPUTS	8 LEDs for binary input indication
BINARY OUTPUTS	8 LEDs for binary output indication
Tx, Rx	Indication transmitted or received data
POWER	Power supply LED indication
STOP	Service jumper
BOOT	Programming
RESET	Programming/Reset
ID	Service jumper

4.4.4 Address and jumpers setting

Programming Firmware

Firmware upgrade is via AT-link (TTL). For programming is necessary to close jumper BOOT. RESET jumper is used to reset the device. Close jumper to reset the device. For programming is used FlashProg PC tool.

4.4.5 LED indication

Binary inputs

Each binary input has LED which indicates input signal. LED is shining when input signal is set, and LED is dark while input signal has other state.

Binary outputs

Binary output LED shining when binary output is set.

Power

Power LED shining when power supply is connected.

4.4.6 Wiring

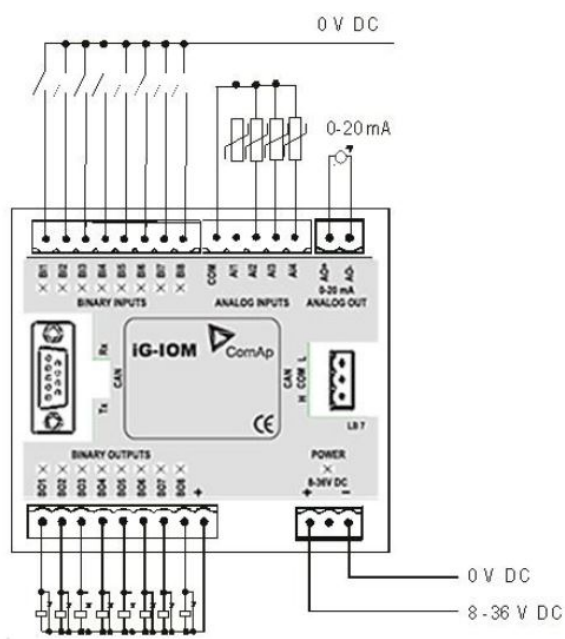

4.4.7 Technical data

Dimension (W×H×D)	95×96×43 mm (3.7'×3.8'×1.7')	
Binary inputs	Input resistance	4700 ohm
	Input range	0 to 36V DC
	Switching voltage level for open contact indication	0 to 2V
	Max voltage level for open contact indication	8 to 36V
Binary outputs (Open collector outputs)	Max current	500mA
	Max switching voltage	36V DC
Analog inputs (Not electric separated)	Resolution	10 bits
	Sensor resistance range	0 to 2400 ohm
	Resistance measurement tolerance	4 % ± 2 ohm out of measured value
Analog output (Not electric separated)	Output current	0 to 20 mA
	resolution	10 bit
Power supply	8 to 36 V DC	

Current cons	100 mA at 24V ÷ 500 mA
Storage temperature	- 40 °C to + 80 °C
Operating temperature	- 30 °C to + 70 °C

[▲ back to IG-IOM](#)

4.5 IGS-PTM



4.5.1 Description

IGS-PTM is modification of standard IG-IOM module with four analog inputs, which can be configured for range:

- > 0 – 250 Ω (suitable for Pt100, Ni100)
- > 0 – 100 mV
- > 0/4 – 20 mA

4.5.2 Dimensions

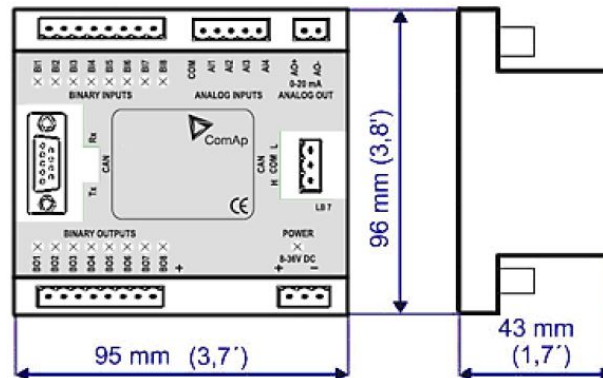

Note: Unit is 35 mm DIN rail mounted.

4.5.3 Terminals

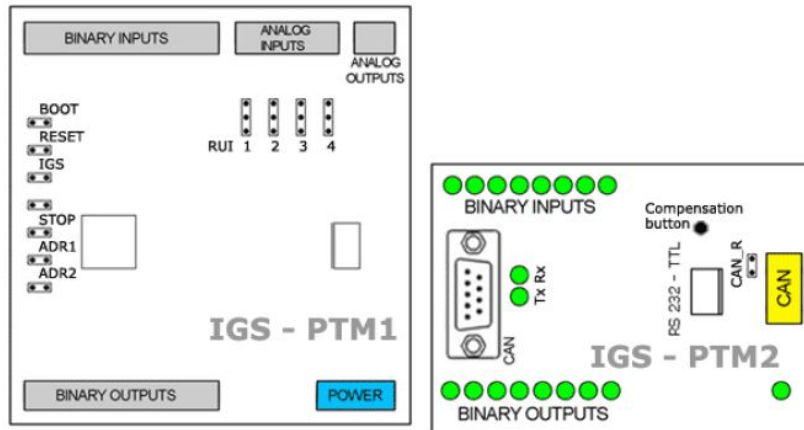

BINARY INPUTS	8 binary input
ANALOG INPUTS	4 analog input
ANALOG OUTPUTS	1 analog output
BINARY OUTPUTS	8 binary output
CAN	CAN1 line
RS232-TTL	Interface for programming
POWER	Power supply
BINARY INPUTS	8 LEDs for binary input indication
BINARY OUTPUTS	8 LEDs for binary output indication
Tx, Rx	Indication transmitted or received data
POWER	Power supply LED indication
CAN_R	Terminating CAN resistor
RUI	Analog inputs configuration
RESET	Programming/reset
BOOT	Programming
IGS	Controller type selection
STOP	Service jumper
ADR1	Module's address offset 1,2
ADR2	
Compensation button	Long wires resistance compensation

Note: Configuration jumpers IGS, ADR1, ADR2 are OPEN by default.
 CAN_R jumper is CLOSE by default (IG-IOM mode).
 Analog inputs are configured for resistance measurement by default.

4.5.4 Address and jumpers setting

Controller type selection

The type of controller to be used with IGS-PTM must be selected via jumper labeled IGS accessible at the lower PCB.

IGS jumper	Controller type
OPEN	IL-NT, IC-NT
CLOSE	IG-NT, IS-NT, IM-NT, ID

Address configur

If IS-NT controller type is selected (by IGS jumper), address of IGS-PTM could be modified via jumpers labeled ADR1 and ADR2.

ADR1	ADR2	ADR offset	BIN module	BOUT module	AIN module
Open	Open	0 (default)	1	1	1
Close	Open	1	2	2	2
Open	Close	2	3	3	3
Close	Close	3	4	4	4

Analog inputs hardware configuration

Analog inputs can be configured for:

- > Resistance measurement
- > Current measurement
- > Voltage measurement

The type of analog inputs is configured via jumpers RUI located on lower PCB.

RUI	Analog input configuration
1 – 2	Resistance measuring
2 – 3	Current measuring
no jumper	Voltage measuring

Sensor characteristic

The controller provides the same user curves for analog inputs on both Inteli-NT controller and PTM. However, the physical measuring range of PTM is different from the one of the controller - the voltage range used on controller is 2.5 V, but on PTM, it is 100 mV. The curves are optimized for resistive sensors with maximum range 250 Ohm. When the same curves are used for voltage sensor, the maximum range must be entered as 250 Ohm, what in fact corresponds to the 100 mV real measurement range. See example in the picture for converting 100 mV measured voltage to 24 V converted value, displayed on controller screen.

Note: It is not possible to use default sensor characteristics (Pt1000, Ni1000 and VDO Temp) because of IGS-PTM measuring range is up to 250 ohms. Sensor characteristics A,B,C can be modified for measuring in range 0-20mA/100, 0-20mA/60, 4-20mA/100, 4-20mA/60 (or different) – see tables below:

Pt100 Resistance [Ω]	Temperature [°C]	Ni100 Resistance [Ω]	Temperature [°C]
92	-20.5	83	-20.6
100	0.0	90	-0.8
108	20.5	97	18.9
116	41.3	105	40.3
123	59.5	113	60.5
131	80.3	121	79.5
139	101.3	130	100.0
146	119.7	139	120.0
154	141.1	148	139.2
169	181.4	169	179.3

Table 4.1 Table of conversion Pt100 or Ni100 resistance to temperature

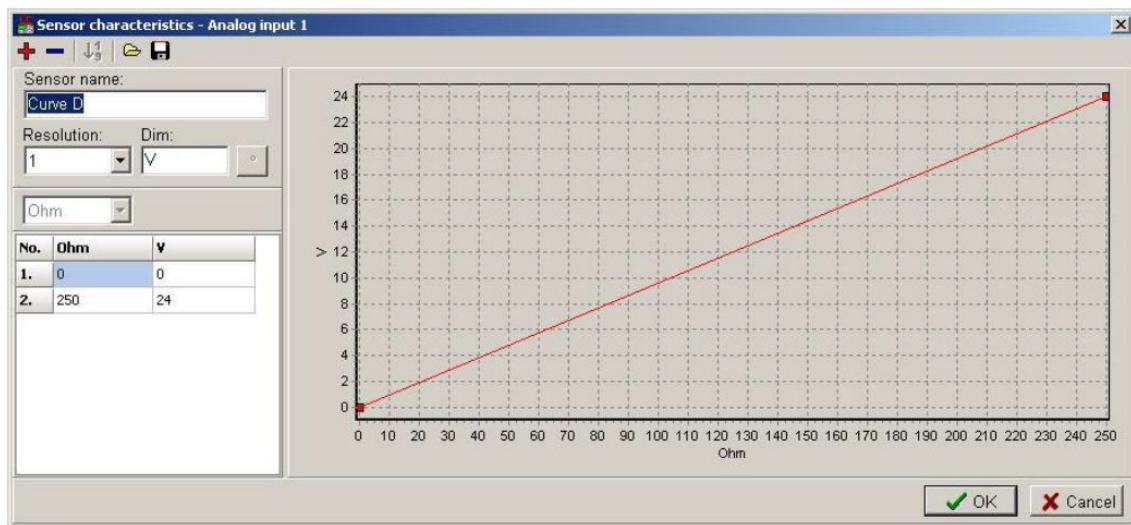

Current conversion table 20 mA/20.0 mA	
Primary	Converted
0	00
40	42
60	63
80	83
100	104

Voltage conversion table 100 mV/100.0 mV	
Primary	Converted
0	00
10	41
40	163
70	285
110	446

Current conversion table 20 mA/100.0	
Primary	Converted
0	0
38	20
57	30
77	40
96	50

Current conversion table 20 mA/20.0 mA	
Primary	Converted
115	119
135	140
155	160
175	181
195	201

Voltage conversion table 100 mV/100.0 mV	
Primary	Converted
140	566
170	685
210	842
230	921
250	999

Current conversion table 20 mA/100.0	
Primary	Converted
116	60
135	70
155	80
174	90
194	100

Current conversion table 20 mA/60.0	
Primary	Converted
0	0
38	12
57	18
77	24
96	30
116	36
135	42
155	28
174	54
194	60

Current conversion table 4-20 mA/100.0	
Primary	Converted
38	0
54	10
77	25
100	40
116	50
139	65
155	75
178	90
194	100

Voltage conversion table 4-20 mV/60.0	
Primary	Converted
38	0
54	6
77	15
100	24
116	30
139	39
155	45
178	54
194	60

Note:

1. If other sensor not included from this list is configured, the unit returns sensor fail.
2. PC software tool configuration must correspond to jumpers setting.
3. Do not configure inputs 5 – 8 of analog inputs module in PC software tool - Analog inputs.
4. Do not configure outputs 2-8 of analog outputs module in PC software tool - Analog outputs.

Programming Firmware

Firmware upgrade is via AT-link (TTL). For programming is necessary to close jumper BOOT. RESET jumper is used to reset the device. Close jumper to reset the device. For programming is used FlashProg PC tool.

4.5.5 LED indication

Binary inputs

Each binary input has LED which indicates input signal. LED is shining when input signal is set, and LED is dark while input signal has other state.

Binary outputs

Binary output LED shining when binary output is set.

Power

LED status	Description
Dark	No required power connected
Quick flashing	Program check failure
One flash and pause	Compensation fail
Three flashes and pause	Compensation successful
Flashes	There is no communication between IGS-PTM and the controller.
Lights	Power supply is in the range and communication between IGS-PTM and controller properly works.

4.5.6 Wiring

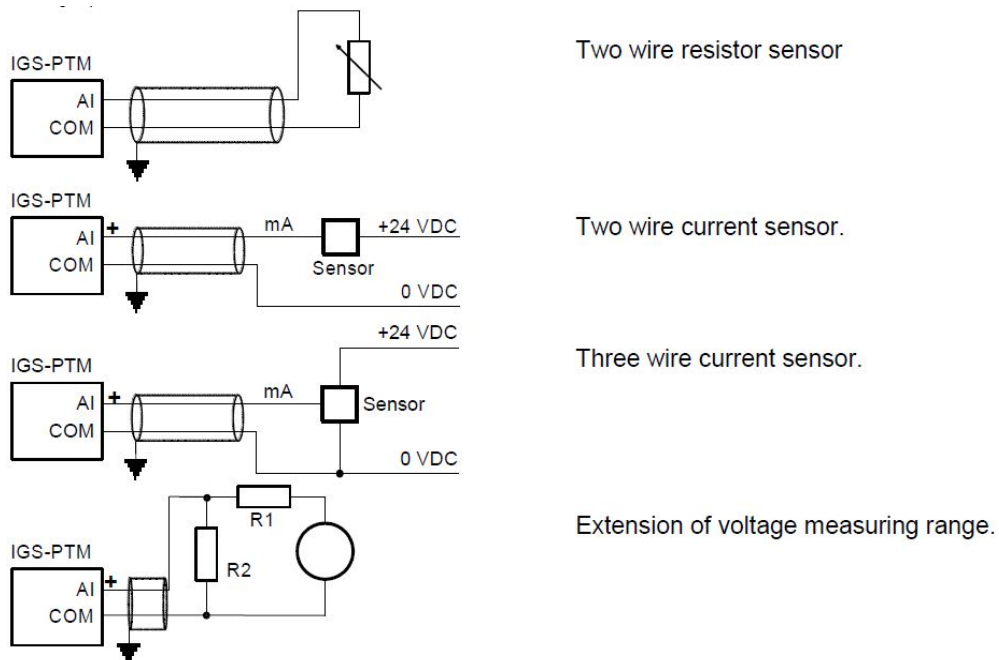

Note: It is not necessary to connect analog inputs COM terminal to negative power supply.

Long wires resistance compensation

Process of compensation:

- > Short all wires to analog sensors at the end (replace sensors with shorting links).
- > Hold the compensation button on IGS-PTM through the hole in upper cover when switching IGS-PTM on.
- > Result of compensation will be shown in 2 seconds by flashing of POWER LED.
 - >> One flash and pause – compensation fail.
 - >> Three flashes and pause – compensation success.
- > Measured lead's resistance is stored in EEPROM memory (separate value for each input) and is subtracted from measured value when resistance measuring.

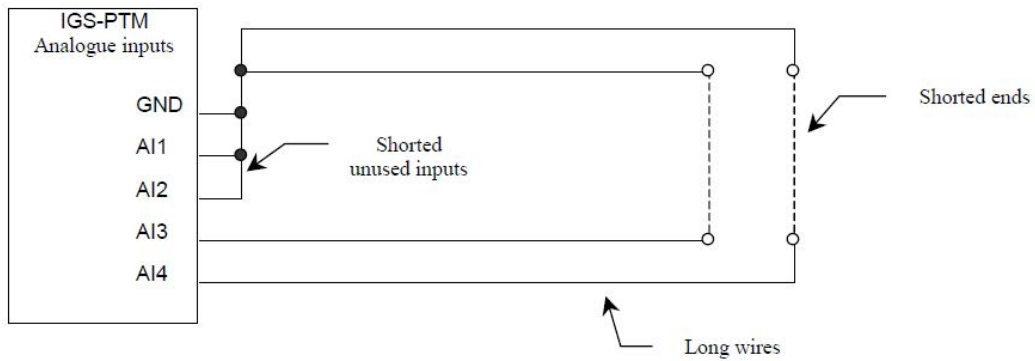

Note: Maximum resistance of two leads (from IGS-PTM to sensor and back) can be 20 Ω . Otherwise the compensation fails. Unused analog inputs must be shorted at the IGS-PTM.

4.5.7 Technical data

Dimension (W×H×D)	95×96×43 mm (3.7'×3.8'×1.7')	
Binary inputs	Input resistance	4700 ohm
	Input range	0 to 36V DC
	Switching voltage level for open contact indication	0 to 2V
	Max voltage level for open contact indication	8 to 36V
Binary outputs (Open collector outputs)	Max current	500mA
	Max switching voltage	36V DC
	Resolution	10 bits
	Sensor resistance range	0 to 250 ohm
Analog inputs (Not electric separated)	Maximal voltage range	0 to 100 mV
	Maximal current range	0 to 20 mA
	Resistance measurement tolerance	1 % ± 2 ohm out of measured value
	Voltage measurement tolerance	1.5 % ± 1 mV out of measured value
	Current measurement tolerance	2.5 % ± 0.5 ohm out of measured value
Analog output (not electric separated)	Output current	0 to 20 mA ± 0.33mA
	resolution	10 bit
Power supply	8 to 36 V DC	
Protection	IP20	
Current consumption	100 mA at 24V ÷ 500 mA	
Storage temperature	-40 °C to + 80 °C	
Operating temperature	- 30 °C to + 70 °C	

🔍 back to IGS-PTM

4.6 IG-MTU/IG-MTU-C/MTU-2-1



4.6.1 Description

Voltage transformer unit, for three wire system, system with separated Neutral or when galvanic separation between generator or mains voltage and controller is required.

- > IG-MTU with voltage ratio 1 : 1, conversion accuracy $\pm 1.5\%$, phase shift $\pm 2^\circ$
- > IG-MTU-2-1 with voltage ratio 2 : 1, conversion accuracy $\pm 1.5\%$, phase shift $\pm 2^\circ$
- > IG-MTU-C with voltage ratio 1 : 1, conversion accuracy $\pm 3\%$, phase shift $\pm 3^\circ$. Additional filter for the cases of extreme distortion of generator voltage by higher harmonics due to inverters etc.

4.6.2 Connectors

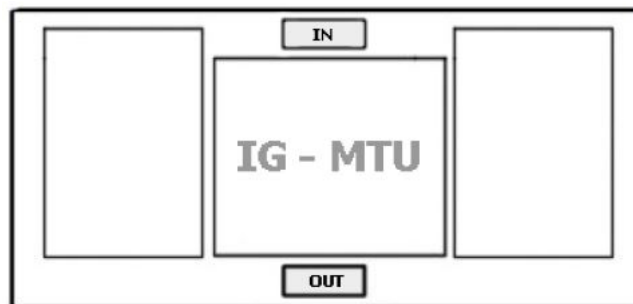

IN	Input voltage
OUT	Output voltage

4.6.3 Wiring

Connect one or two IG-MTU units to separate generator and Mains/bus voltage from controller.

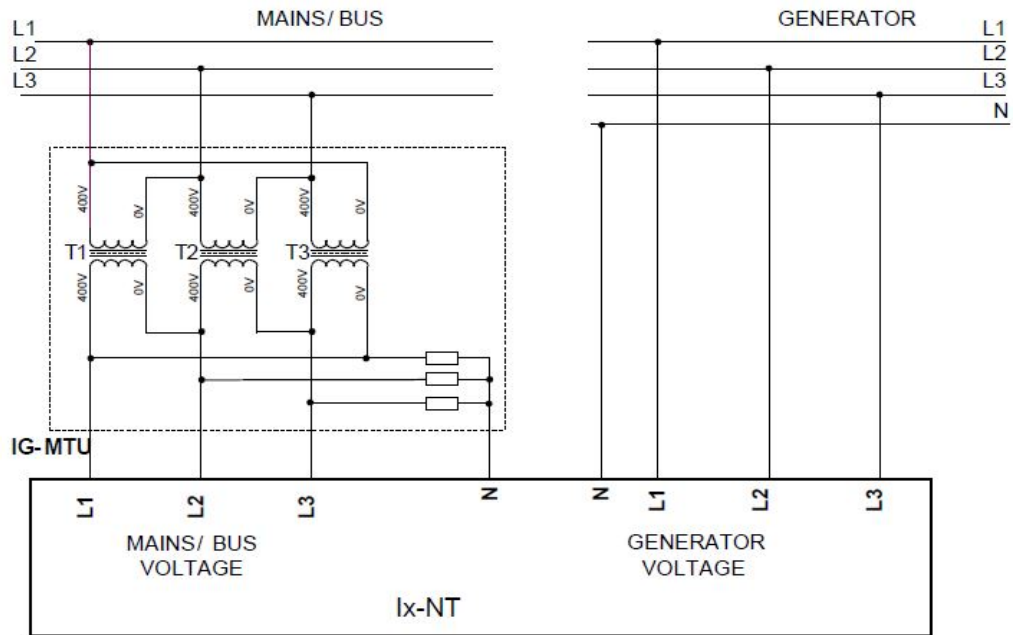

Image 4.4 Three wire mains

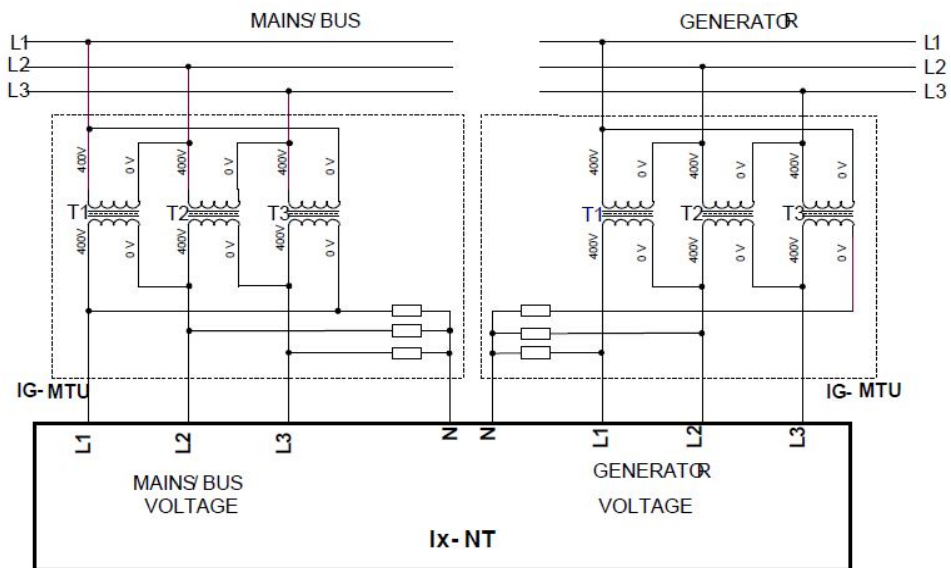
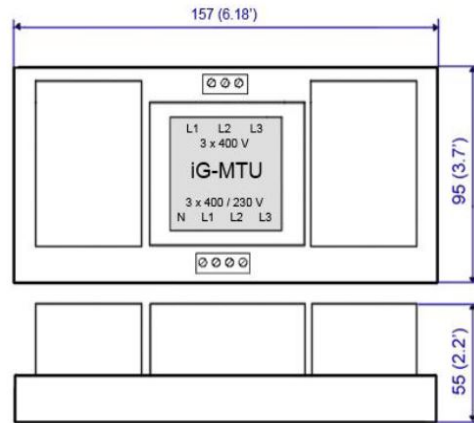

Image 4.5 Three wire mains and three wire gen-set or electric separation

Note: IG-MTU-C can be connected **only with classical line controllers!** We recommend connect IG-MTU and IG-MTU-2-1 only when is needed separated neutral or when is necessary galvanic separate mains/generator and controller.

🔍 back to Table of modules

4.6.4 Dimensions



Unit is 35 mm DIN rail mounted.

4.6.5 Technical data

Dimension (W×H×D)	157×55×95 mm (6.18'×2.2'×3.7')
Interface to controller	Direct mounted (SUB25)
Primary voltage Ph-Ph	3×400 VAC/50Hz (3×480 VAC/60 Hz) 3×600 VAC/50Hz (3×720 VAC/60 Hz)
Secondary voltage Ph-N	3× 230 V AC (3×277 VAC/60 Hz), 5 VA 3× 173 V AC (3×208 VAC/60 Hz), 5 VA
Primary/secondary Phase shift	± 2° ± 3°
Conversion accuracy	± 1.5% at 50Hz ± 3.0% at 50Hz
Storage temperature	- 40 °C to + 80 °C
Operating temperature	- 30 °C to + 70 °C

🔍 back to [IG-MTU/IG-MTU-C/MTU-2-1](#)

4.7 IL-NT-AOUT8

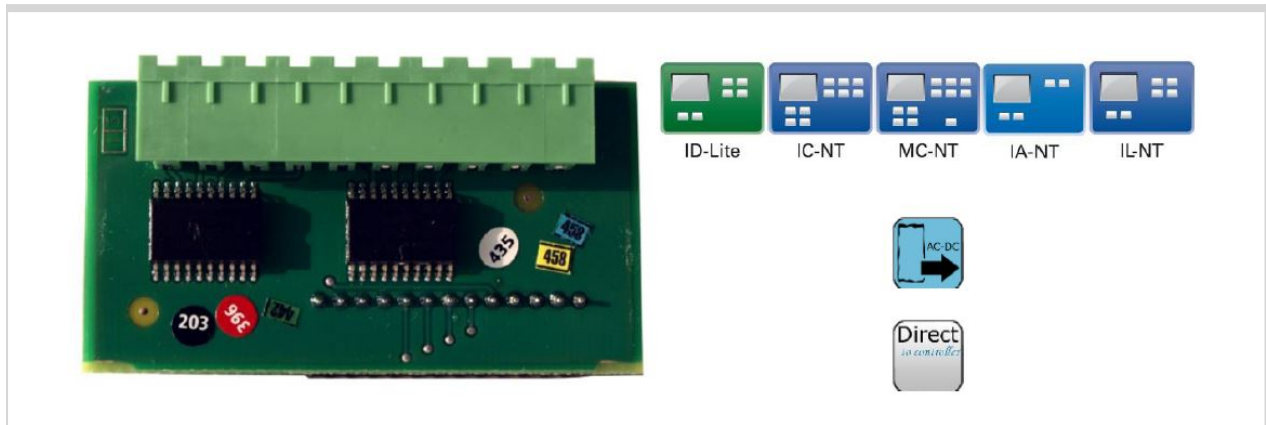

4.7.1 Description

Analog output module, optional plug in card IL-NT AOU8 provides eight Pulse-With-Modulation (PWM) outputs. These are intended to drive VDO style analog gauges. This is to provide visual indication of typically ECU values without installing additional sensors on the engine. PWM signal emulates sensor which would be typically mounted on the engine.

Any value from controller may be configured to the outputs. Use LiteEdit PC SW to configure corresponding sensor/gauge curve and value selection.

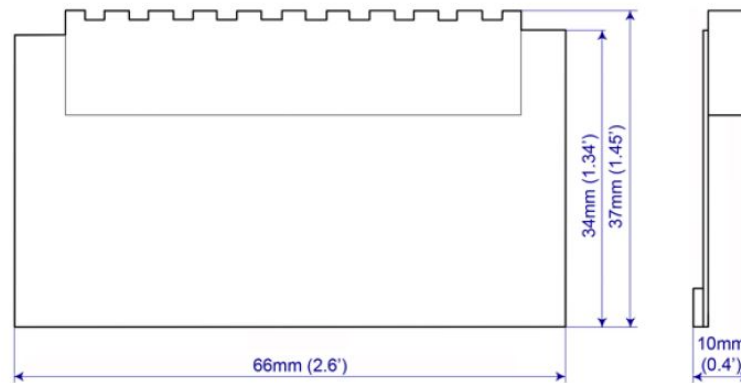

4.7.2 Connectors

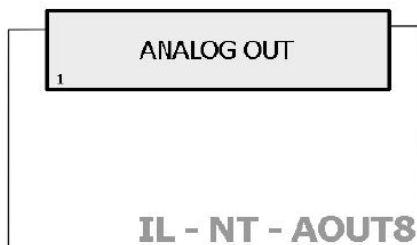

ANALOG OUT – port 2-10	Analog out for gauges
ANALOG – port OUT 1	GND
ANALOG – port OUT 2	Power supply voltage

4.7.3 Wiring

IL-NT-AOUT8 wiring example for Dacon gauges

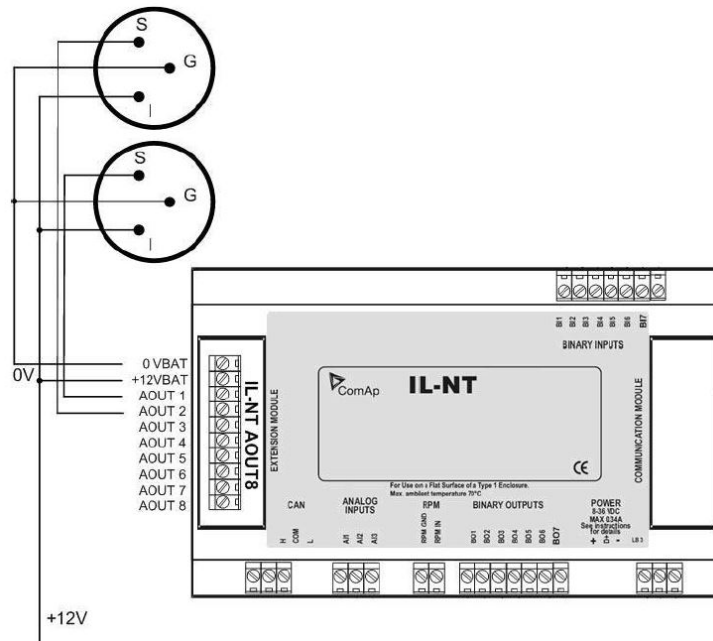

Example of default analog output curves

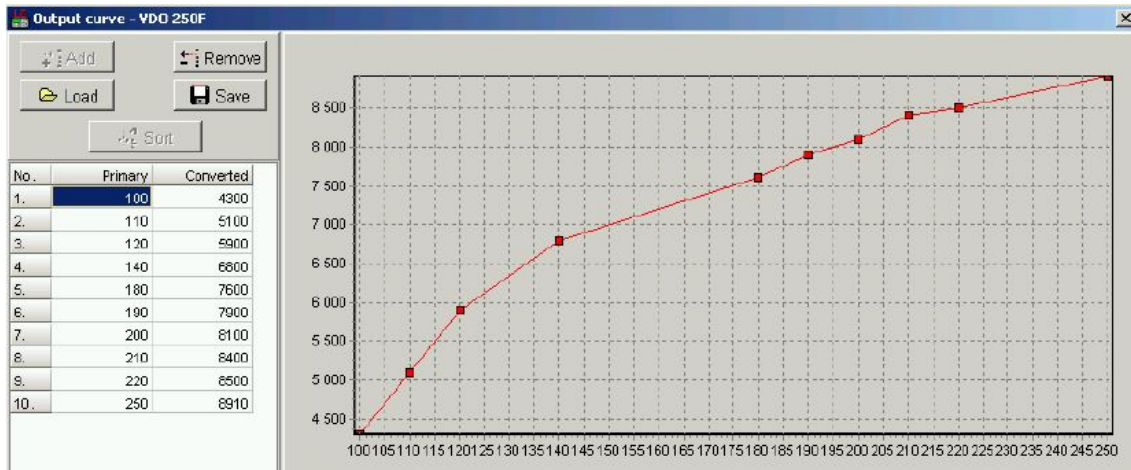

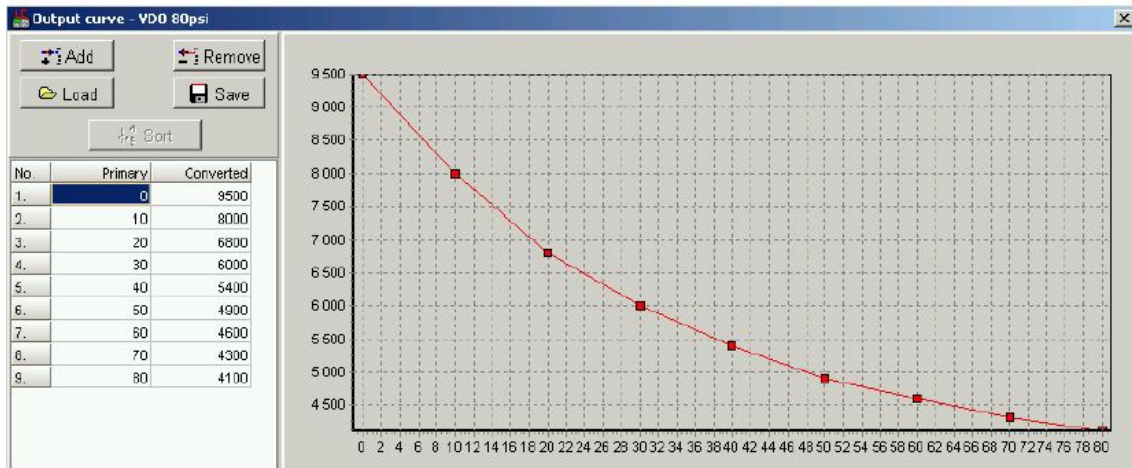

4.7.4 Technical data

Dimension (W×H×D)	66×37×10 mm (2.6'×1.45'×0.4')
Interface to controller	Direct mounted
PWM output	Open collector, max. 0.5A
Power supply	12 to 24V DC
Storage temperature	- 40 °C to + 80 °C
Operating temperature	- 30 °C to + 70 °C

🔍 back to IL-NT-AOUT8

4.8 IL-NT-RS232

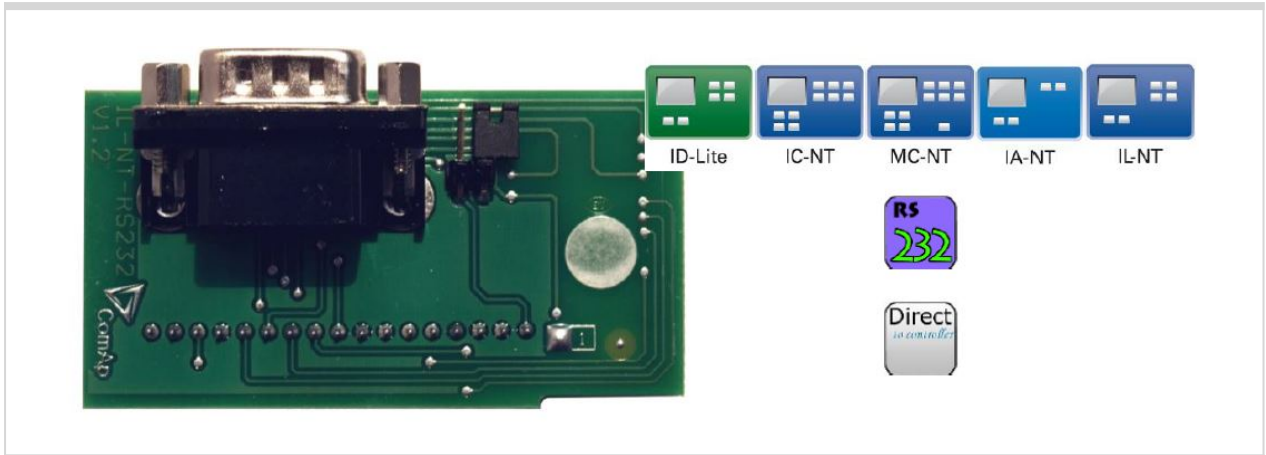

4.8.1 Description

Communication module, optional plug in card IL-NT RS232 provides additional serial interface for controller.

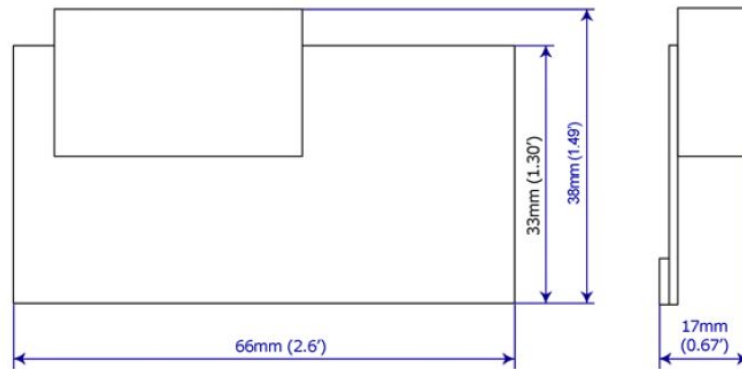

4.8.2 Connectors

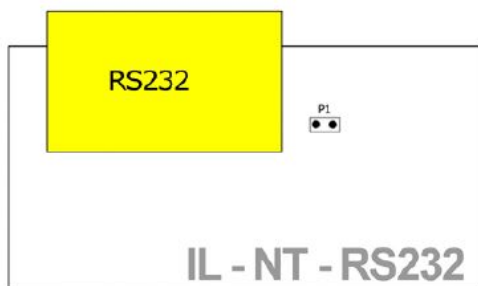

RS232	RS232 line
P1	Programming

4.8.3 Wiring

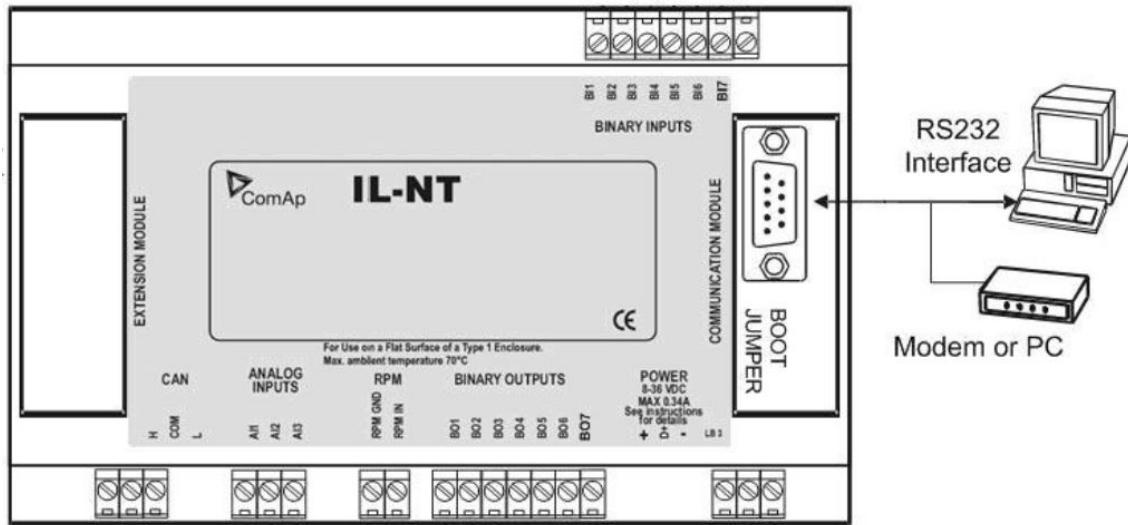

4.8.4 Technical data

Dimension (W×H×D)	66×38×17 mm (2.6'×1.49'×0.67')
Interface to controller	Direct mounted
RS232	Standard RS232 communication interface
Storage temperature	- 40 °C to + 80 °C
Operating temperature	- 30 °C to + 70 °C

🔍 [back to IL-NT-RS232](#)

4.9 IL-NT-S-USB



4.9.1 Description

Communication module, optional plug in card IL-NT USB provides additional USB interface for controller.

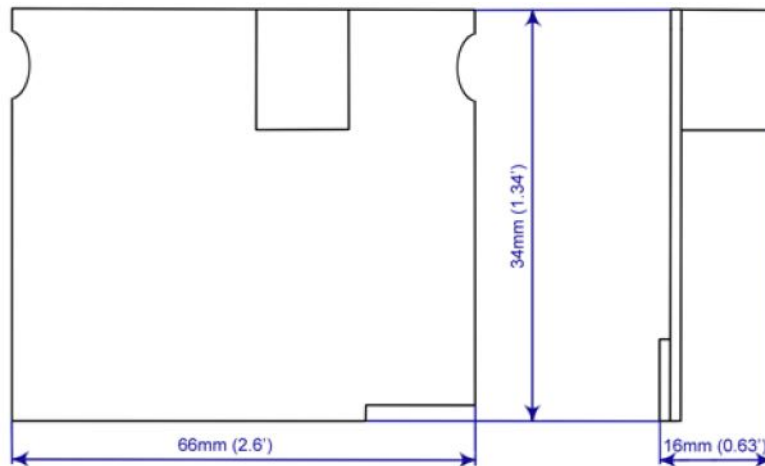

4.9.2 Connectors

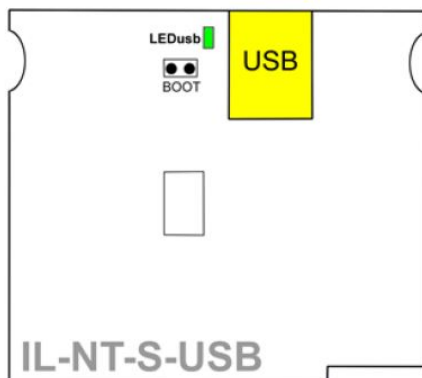

USB	RS232 line
LEDusb	Data on USB line (Rx and Tx)
BOOT	Programming

4.9.3 LED Indications

LEDusb indicates active communications on USB line. When LEDusb blink data are receiving or transmitting on USB line.

4.9.4 Wiring

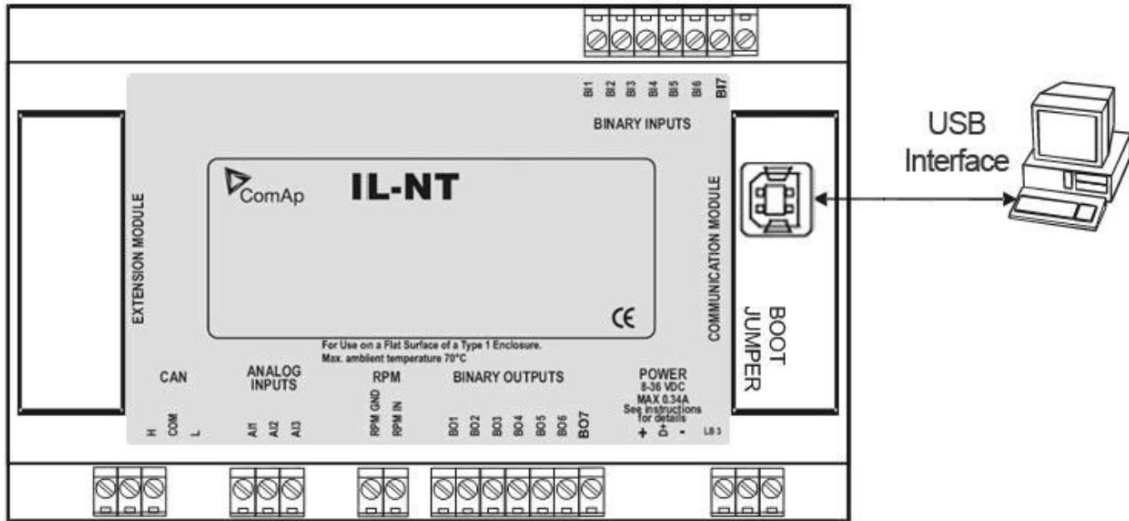

4.9.5 Technical data

Dimension (W×H×D)	66×34×16 mm (2.6'×1.34'×0.63')
Interface to controller	Direct mounted
USB	Standard USB communication interface
Storage temperature	- 40 °C to + 80 °C
Operating temperature	- 30 °C to + 70 °C

🔍 back to IL-NT-S-USB

4.10 IL-NT-FCM



Note:

* This module can be use only with InteliLog controller.

4.10.1 Description

InteliLog fuel counter module is optional plug-in card. Through this card controller can read rectangular signal on 2 inputs. The module has to be configured in LiteEdit software. The impulse inputs are used for evaluation of incrementing values FuelConH and FuelAutRefTot in group Fuel mgmt.

4.10.2 Connectors

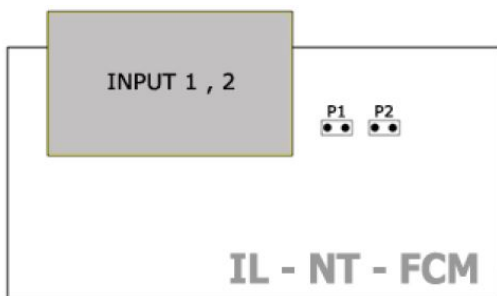

INPUT1	Fuel consumption per hour
INPUT2	Absolute fuel inflow into tank
P1,P2	Input settings

4.10.3 Address and jumper setting

Module inputs can be set for voltage or open collector input signal. When jumper P1 is open, module input is sets to voltage input, jumper P2 is closed for open collector input. Jumper P1 configures input 1 and jumper P2 input 2.

4.10.4 Others information

FuelManRefil [l]

Setpoint group	LiteEdit configuration		
Range [units]	-32 000 – 32 000 l		
Default value	0	Force value Alternative config	YES
Step	1 l		
Comm object		Related applications	AMF, MRS
Config level	Standard		
Setpoint visibility	Always		
Description			
Actually refilled amount of fuel in liters. After editing this setpoint, its value is added to the actual value of counter FuelManRefTot in values group Fuel Mgmt and immediately reset to 0.			
<i>Note: Editation window of this setpoint is automatically entered after holding the button Refil on the unit panel for minimum 1 s.</i>			

ConPulseRate [ppl]

Setpoint group	LiteEdit configuration		
Range [units]	1 – 9999 ppl		
Default value	1	Force value Alternative config	YES
Step	1 ppl		
Comm object		Related applications	AMF, MRS
Config level	Standard		
Setpoint visibility	Always		
Description			
“Pulses per liter” constant of fuel flow sensor connected to the first pulse input of IL-NT-FCM module. By setting this constant, the proper counting of FuelConH value in values group Fuel Mgmt is provided, showing the hourly fuel consumption.			

AuRefPulseRate [ppl]

Setpoint group	LiteEdit configuration		
Range [units]	1 – 9999 ppl		
Default value	1	Force value Alternative config	YES
Step	1 ppl		
Comm object		Related applications	AMF, MRS
Config level	Standard		

Setpoint visibility	Always
Description	<p>“Pulses per liter” constant of fuel flow sensor connected to the second pulse input of IL-NT-FCM module.</p> <p>By setting this constant, the proper counting of FuelAutrefTot value in values group Fuel Mgmt is provided, showing the total amount of fuel refilled through this sensor.</p>

4.10.5 Wiring

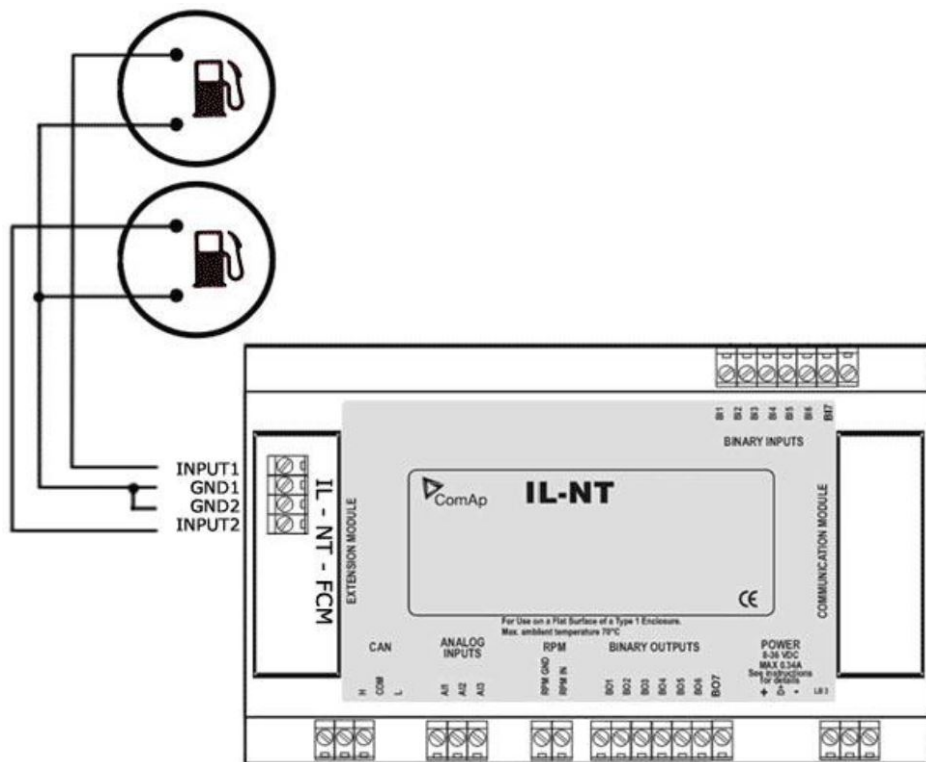

4.10.6 Technical data

Dimension (W×H×D)	66×34×16 mm (2.6'×1.34'×0.63')
Interface to controller	Direct mounted
Pulse input	Max 2kHz, input voltage 9 to 27Vpp
Storage temperature	- 40 °C to + 80 °C
Operating temperature	- 30 °C to + 70 °C

🔍 back to IL-NT-FCM

4.11 IL-NT-RS232-485

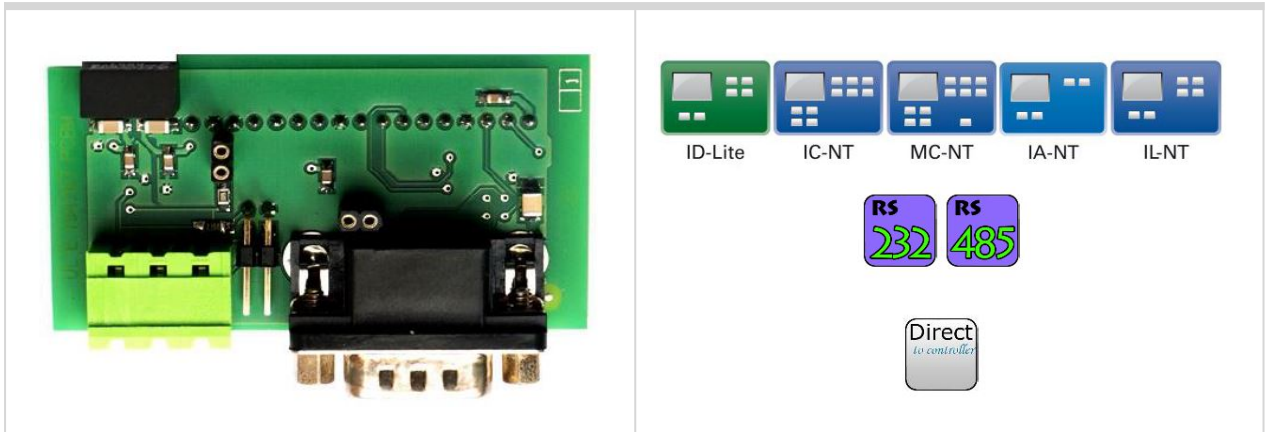

4.11.1 Description

The IL-NT-RS-232-485 is a two port module with RS232 and RS485 interfaces at independent COM channels. The RS232 is connected to COM1 and RS485 to COM2.

4.11.2 Connectors

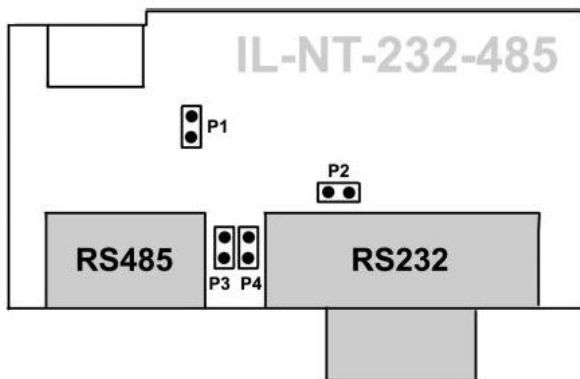

COM1	RS232 line
COM2	RS485 line
P1,P2	Balancing resistor
P3	Terminator jumper
P4	Boot jumper

4.11.3 Wiring

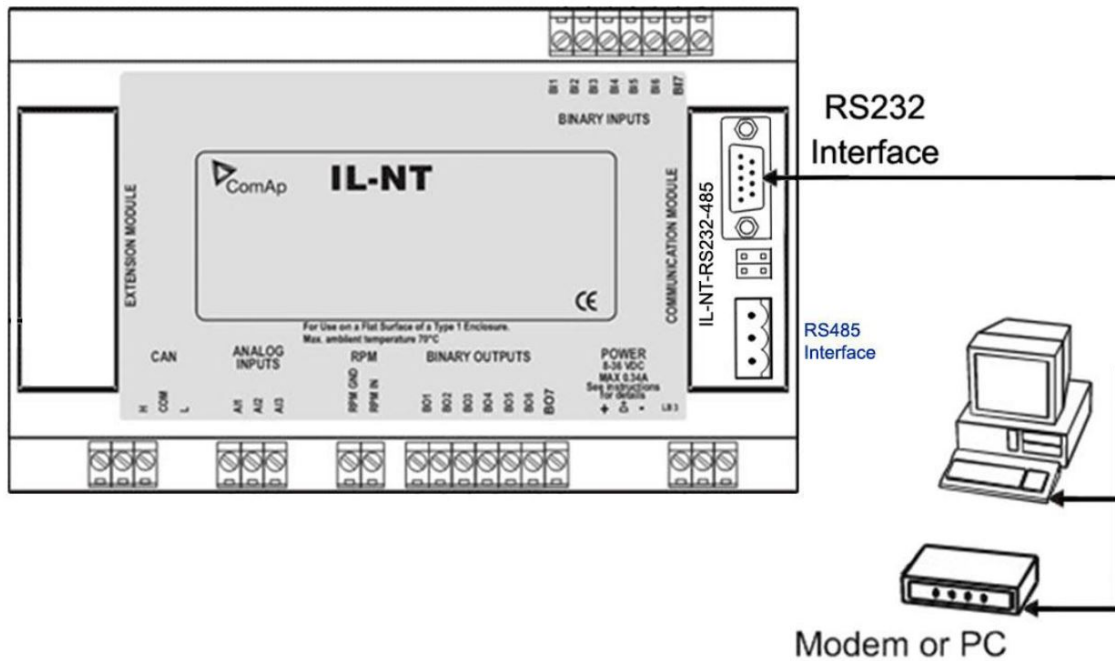

4.11.4 Technical data

Dimension (W×H×D)	66×38×17 mm (2.6'×1.49'×0.67')
Interface to controller	Direct mounted
RS232	Standard communication interface
RS485	Standard communication interface
Storage temperature	- 40 °C to + 80 °C
Operating temperature	- 30 °C to + 70 °C

Note: Communication speed is depends on controller type and its settings.

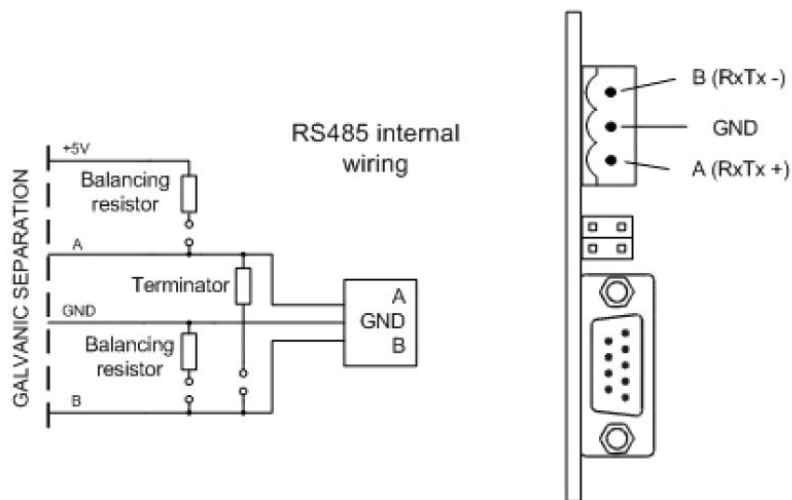

⬅ back to IL-NT-RS232-485

4.12 IL-NT-BIO8

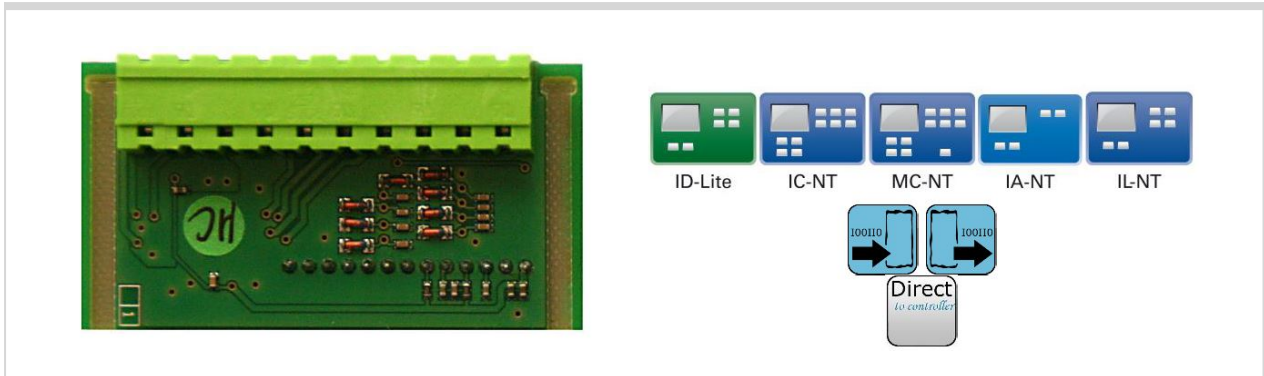

4.12.1 Description

IL-NT BIO8 is optional plug-in module with 8 binary inputs or 8 binary open collector outputs. In LiteEdit PC tool (version 4.4 and higher) it is possible to easily choose and configure particular I/O will be binary input or output.

4.12.2 Connectors

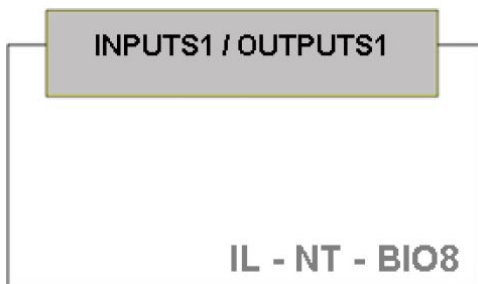

INPUTS1	8 mixed binary inputs or
OUTPUTS1	outputs

4.12.3 Address and jumper setting

There is no possibility to set address of module.

4.12.4 Others information

This module is configurable in LiteEdit – Modify configuration – Extension plug-in modules – IL-NT-BIO8.

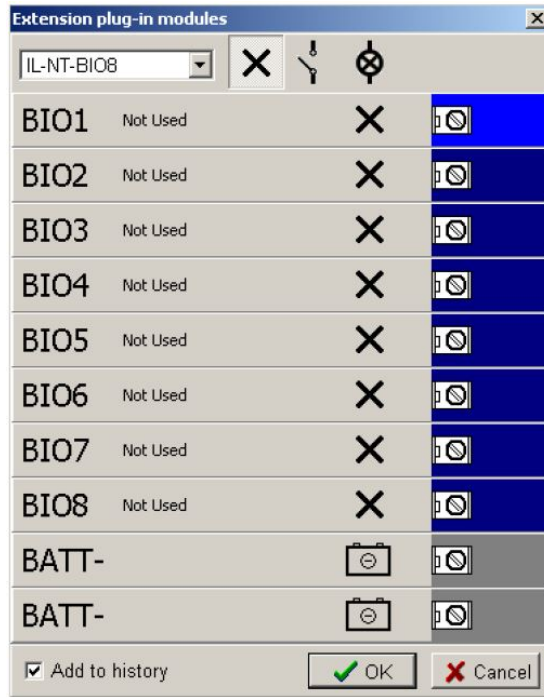

4.12.5 Wiring

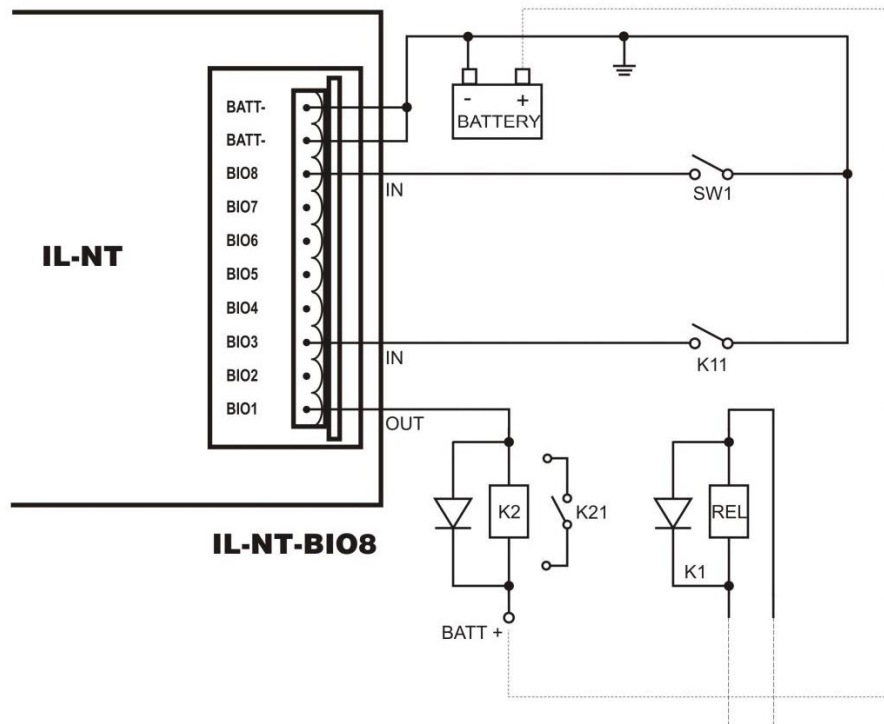

4.12.6 Technical data

Dimension (W×H×D)	66×34×16 mm (2.6'×1.34'×0.63')	
Interface to controller	Direct mounted	
Binary inputs	Input resistance	4700ohm
	Max. input signal	0 – 36VDC
	Logical H (1)	< 0.8 VDC
	Logical L (0)	> 2 VDC
Binary open collector outputs	Max current (per output)	0.5 A
	Max switching current (common)	2.0 A
	Max switching voltage	36 VDC
Storage temperature	- 40 °C to + 80 °C	
Operating temperature	- 30 °C to + 70 °C	

[🔍 back to IL-NT-BIO8](#)

4.13 IC-NT-CT-BIO7

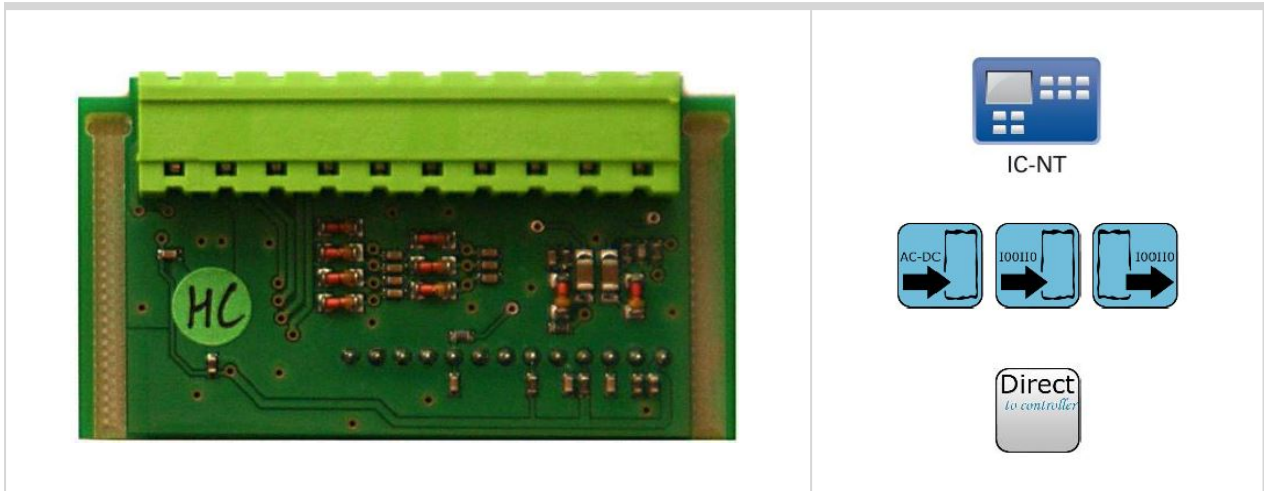

4.13.1 Description

IC-NT CT-BIO7 is equipped with one AC current (CT) measuring input and up to 7 binary inputs or outputs. In LiteEdit PC tool (version 4.4 and higher) it is possible to easily choose and configure particular I/O will be binary input or output.

Note: Current measuring input is intended to measure one phase (AC) current of mains and to limit Export/Import to/from mains to zero value during parallel to mains operation. This is case of SPtM application, so current input of IC-NT CT-BIO7 module is useful for SPtM controllers only.

4.13.2 Connectors

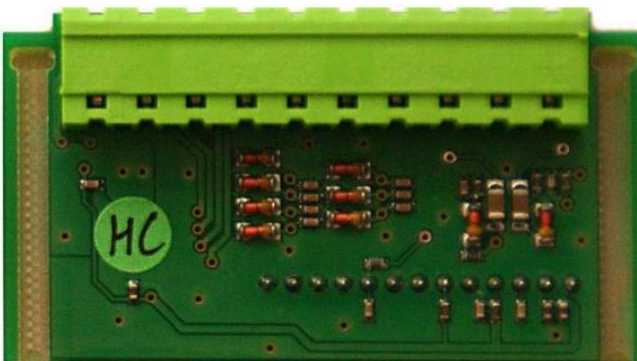

INPUTS1	7 mixed binary inputs or
OUTPUTS1	outputs

4.13.3 Address and jumper setting

There is no possibility to set address of module.

4.13.4 Others information

This module is configurable in LiteEdit – Modify configuration – Extension plug-in modules – IL-NT-BIO8.

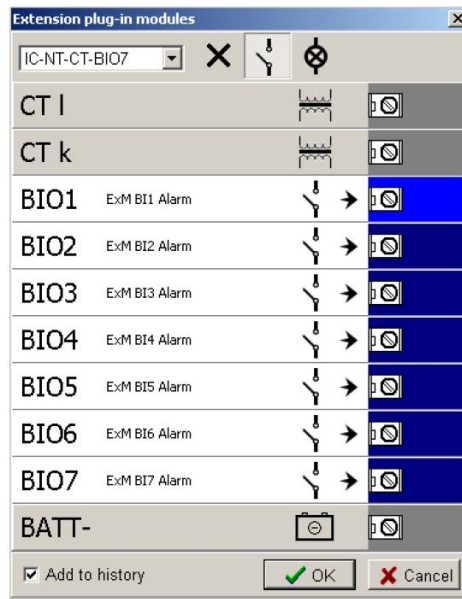

Im CT Ratio [A/5A]

Setpoint group	LiteEdit configuration		
Range [units]	1 – 5000 [A/5A]		
Default value	1	Force value Alternative config	YES
Step	1		
Comm object		Related applications	AMF, MRS
Config level	Standard		
Setpoint visibility	Always		
Description			
This setpoint defines mains current transformer ratio for current measuring input of IC-NT-CT-BIO7 module.			

PeakLevelStart [kW]

Setpoint group	LiteEdit configuration		
Range [units]	PeakLevelStop – 3200 [kW]		
Default value		Force value Alternative config	YES
Step	0.1 or 1		
Comm object		Related applications	AMF, MRS
Config level	Standard		
Setpoint visibility	Always		
Description			
Load consumption level the gen-set has to start at. Function is inactive when PeakAutS/Sdel = OFF. Genset start is PeakAutS/S Del delayed after the consumption of the Load exceeds the PeakLevelStart limit.			

PeakLevelStop [kW]

Setpoint group	LiteEdit configuration		
Range [units]	0 - PeakLevelStart [kW]		
Default value		Force value Alternative config	YES
Step	0.1 or 1		
Comm object		Related applications	AMF, MRS
Config level	Standard		
Setpoint visibility	Always		
Description			
Load consumption level the gen-set has to stop at. Genset stop is PeakAutS/Sdel delayed after PeakLevelStop limit is reached. Load consumption is calculated (not directly measured) as a sum of gen-set and mains active power.			

PeakAutS/S Del [s]

Setpoint group	LiteEdit configuration		
Range [units]	0 (OFF) - 600 [s]		
Default value	0	Force value Alternative config	YES
Step	1 [s]		
Comm object		Related applications	AMF, MRS
Config level	Standard		
Setpoint visibility	Always		
Description			
The condition for the "peak" automatic start or stop must be valid for time period longer than value of this setpoint to execute the automatic start or stop. Adjusting 0 causes stop of the gen-set (if there is no other demand for running) and disable the automatic start.			

Export Limit [-]

Setpoint group	LiteEdit configuration		
Range [units]	DISABLED / ENABLED [-]		
Default value		Force value Alternative config	YES
Step	-		
Comm object		Related applications	AMF, MRS
Config level	Standard		
Setpoint visibility	Always		
Description			
Tells controller to activate protection against power export to the mains. The function limits gen-set requested power to hold import power higher or equal to the setpoint Export kW. DISABLED / ENABLED			

Export kW [kW]

Setpoint group	LiteEdit configuration		
Range [units]	-32000 - 32000 [kW]		
Default value	0	Force value Alternative config	YES
Step	1 [kW]		
Comm object		Related applications	AMF, MRS
Config level	Standard		
Setpoint visibility	Always		
Description			
Defines max limit for export / import in case Export Limit setpoint is set as ENABLED. Negative value means import limit, positive value export limit zero means no export/import.			

4.13.5 Wiring

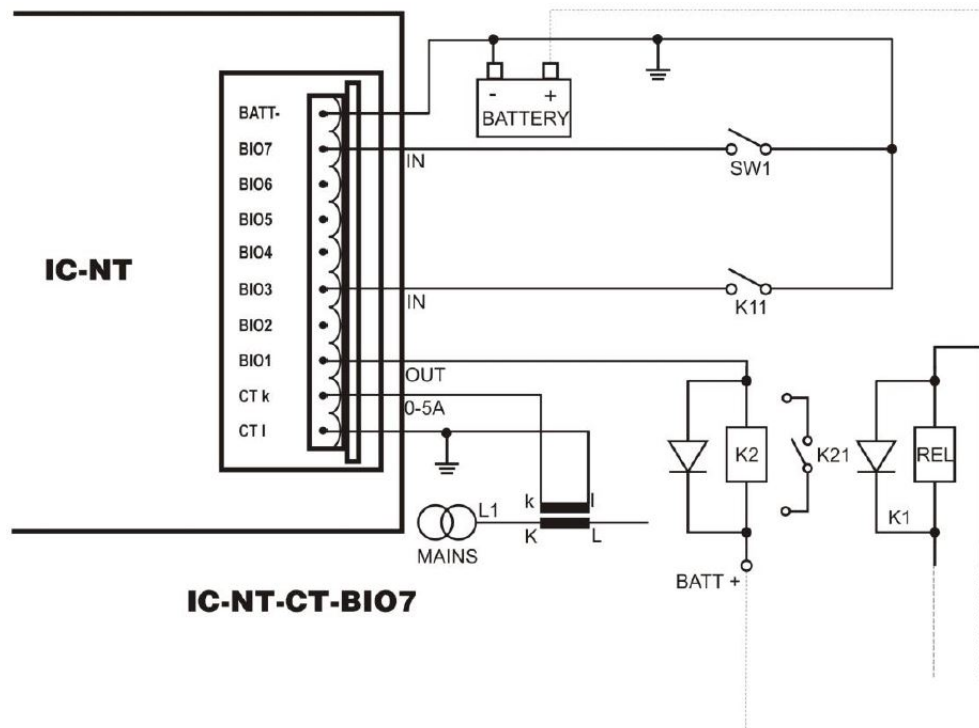

4.13.6 Technical data

Dimension (W×H×D)	66×34×16 mm (2.6'×1.34'×0.63')	
Interface to controller	Direct mounted	
Current measuring input	Nominal current	5 A
	Max. current	10 A
	Current accuracy	2% from nominal
	Max. peak current	150A / 1s
Binary inputs	Input resistance	4700ohm
	Max. input signal	0 – 36VDC
	Logical H (1)	< 0.8 VDC
	Logical L (0)	> 2 VDC
Binary open collector outputs	Max current (per output)	0.5 A
	Max switching current (common)	2.0 A
	Max switching voltage	36 VDC
Storage temperature	- 40 °C to + 80 °C	
Operating temperature	- 30 °C to + 70 °C	

[🔍 back to IC-NT-CT-BIO7](#)

4.14 IL-NT-IO1

IL-NT IO1 is optional plug-in card. Through this card controller can drive up to 4 proportional valves and to used 4 additional binary inputs. The 0V (GND) terminal is internally wired with battery minus internally, the 12-24V (+Ubat) terminal is wired to battery plus power supply of IntelliDrive Lite controller.

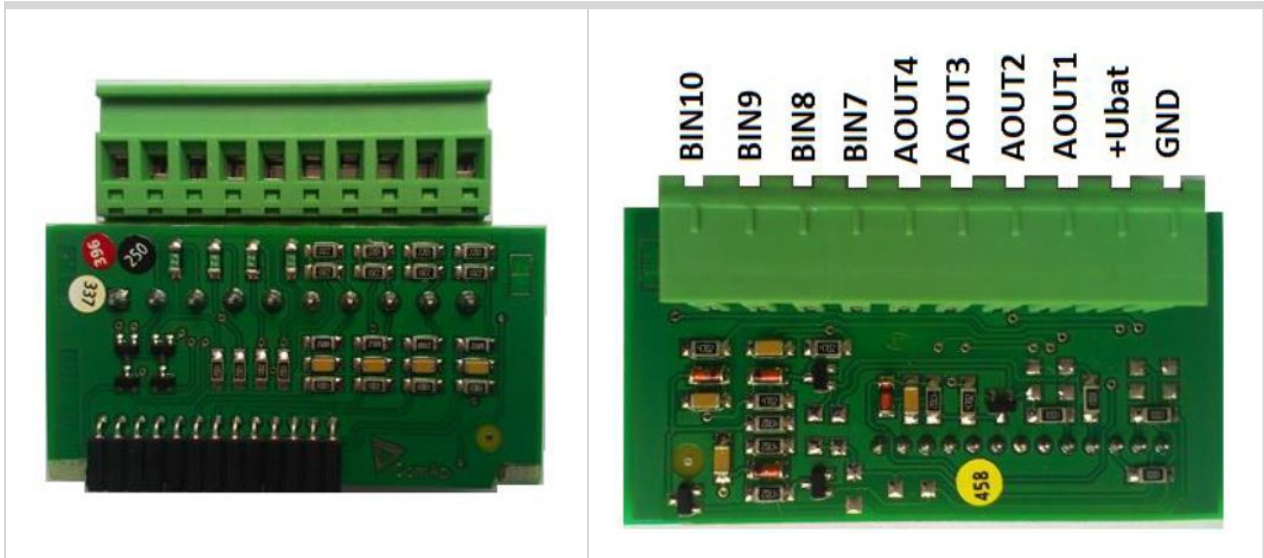

There should be, not more than 1V, lower voltage compare to adjusted % of +Ubat voltage.

Note: Analog output shorted to ground more than one second can damage the output circuit.

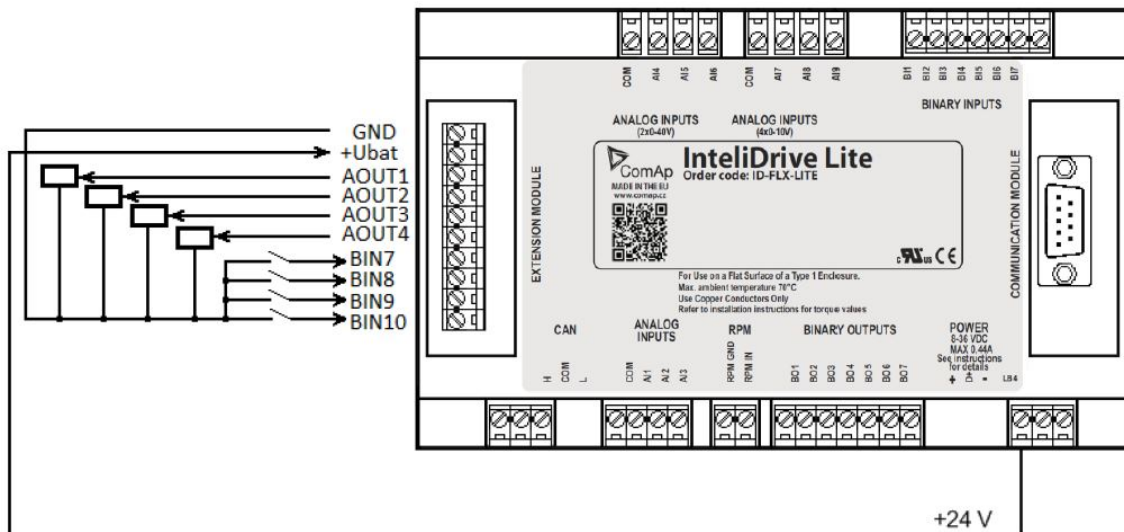

◀ back to IL-NT-IO1

4.15 IL-NT-AIO

IL-NT AIO is optional plug-in card. This card offers additional four analog inputs and one analog output. Analog inputs can be use for different types of sensor (resistive, current and voltage) and variable analog output, which can be used as PWM. Adjustment of extension plug-in module is possible via LiteEdit too.

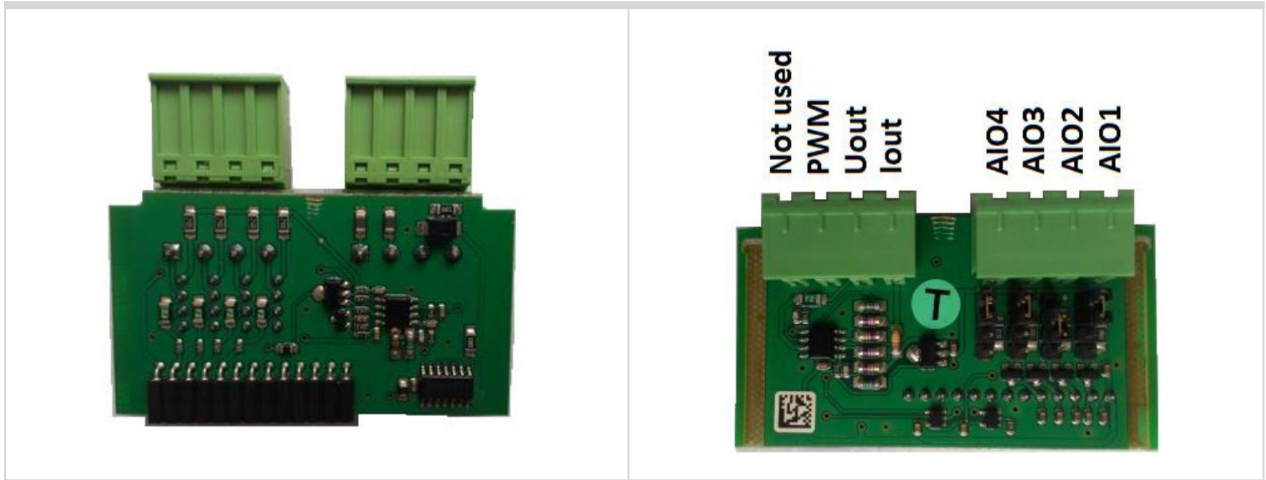

Type of analog input is selectable by jumper. Each analog input has own line of jumper position. The top position (closest to green connector on the pic above) is for resistive input, central position for voltage input and lowest position is for current input.

AI1 – AI4	2600 Ohm / 4V / 20 mA
Iout	0 – 20 mA (max 22mA) max 100 Ohm load
Uout	0 – 4.5V (max 10mA)
PWM	PWM 5V / 15mA / 500 Hz
Not used	Do not connect!

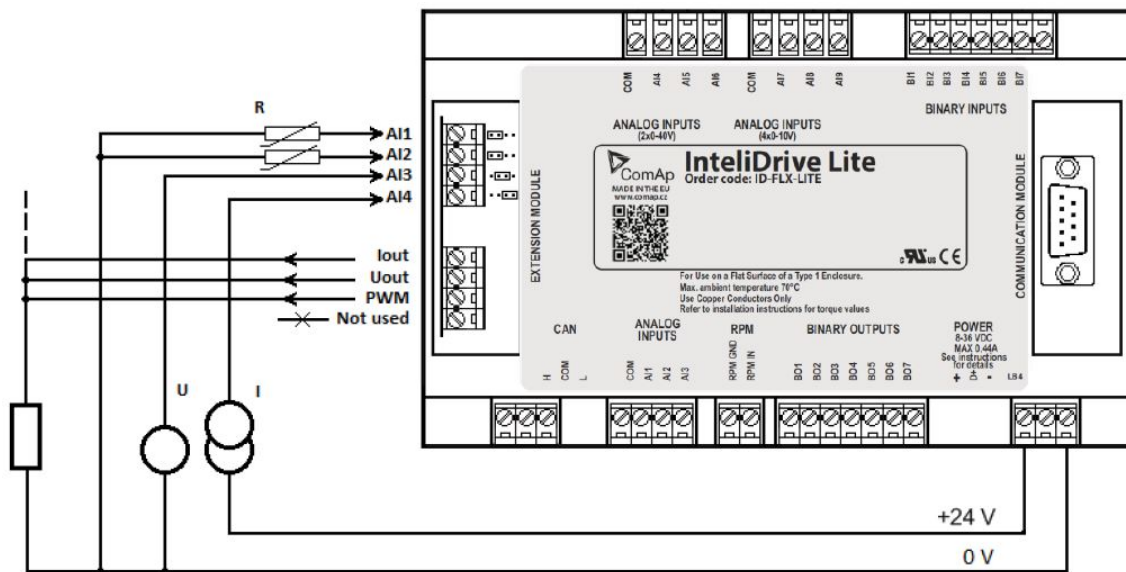

◀ back to IL-NT-AIO

◀ back to Modules

4.16 Intel RPU

Intel RPU (Redundant Protection Unit) is an extension module for Marine applications ensuring basic functionality in case of failure of the Main Unit (Accessory Modules). It has features as Built-in self-diagnostics, Fuel solenoid and Stop solenoid control, Emergency stop and Overspeed protection with analog RPM setting.

The unit is not a full-featured replacement of IntelliDrive Marine unit, it is a module used for increasing reliability of the whole system.

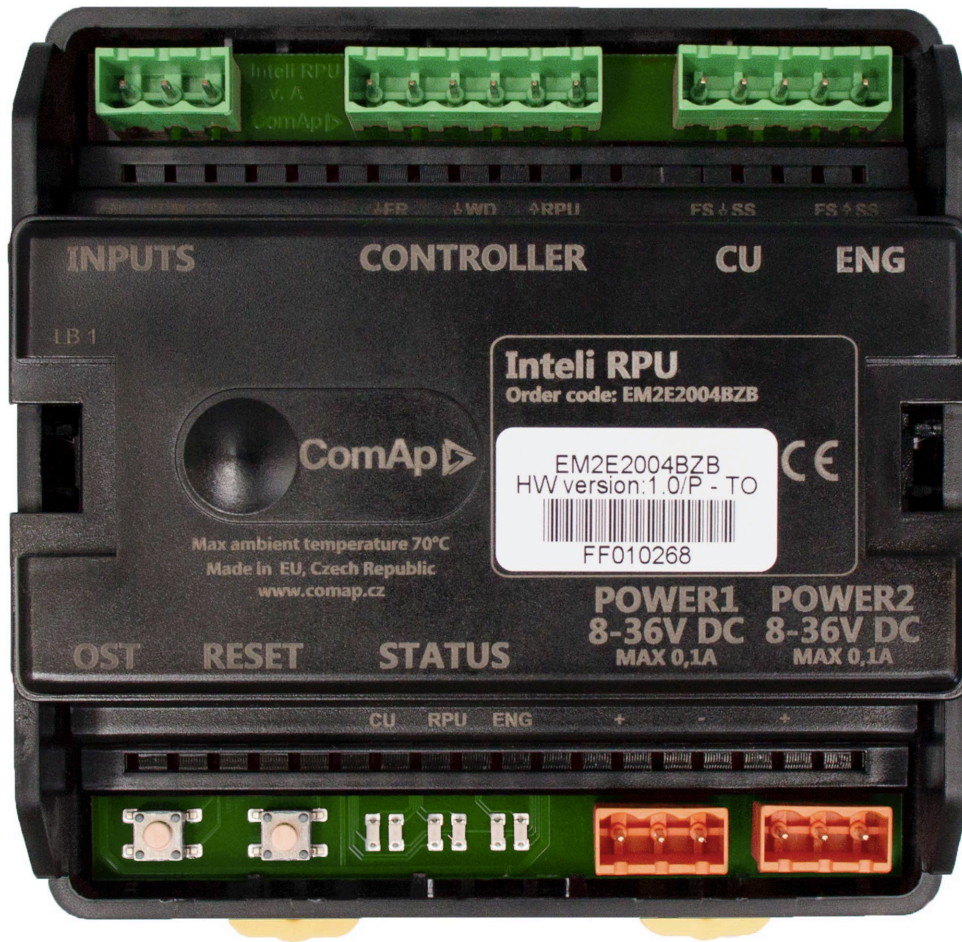

4.16.1 Installation and wiring

Dimensions

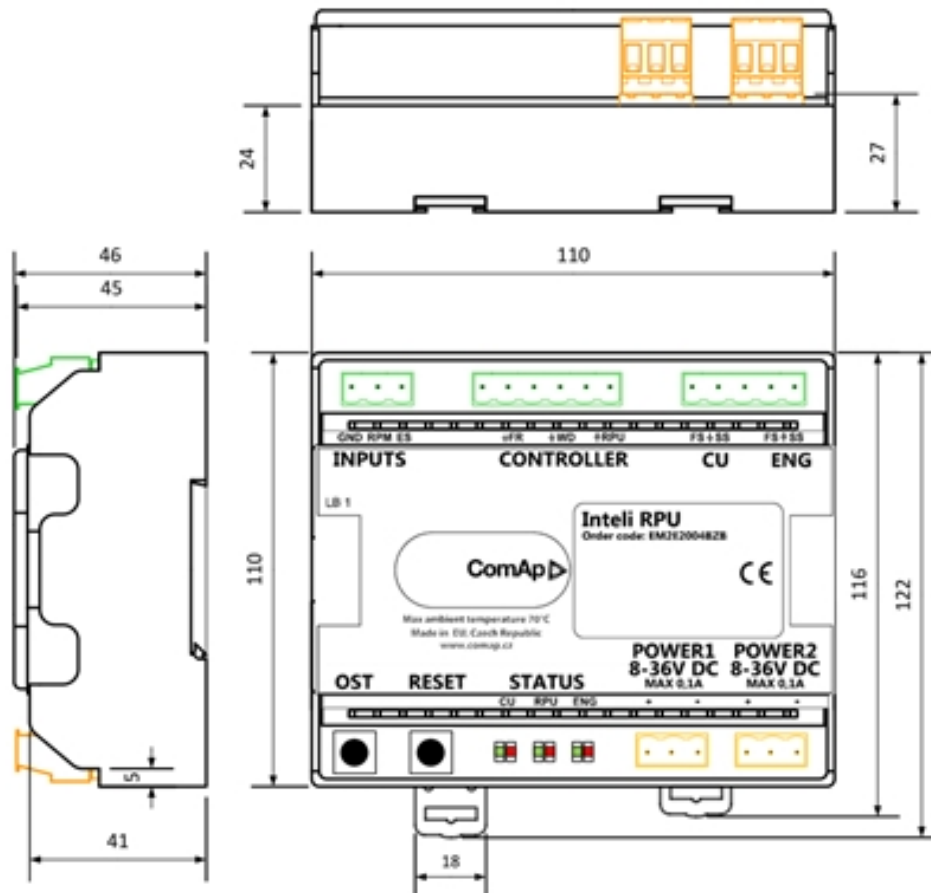

Terminals

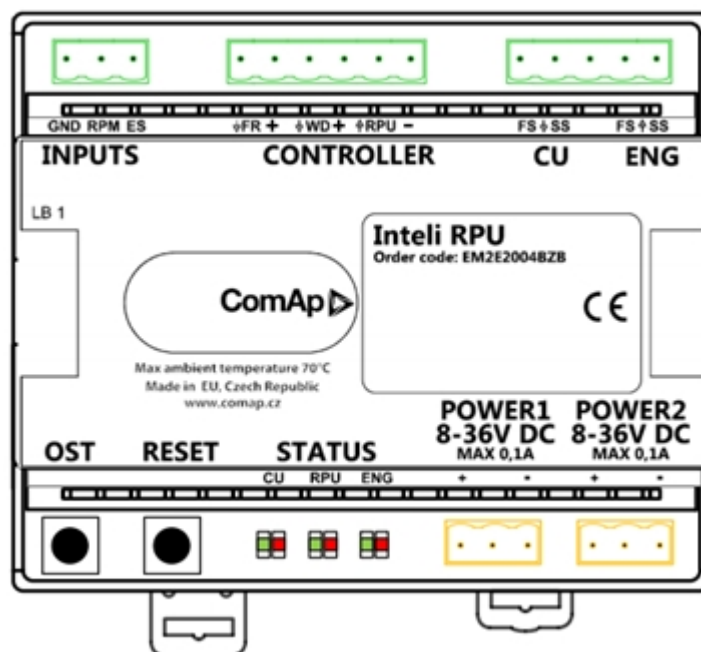

Input group	Caption	Description
INPUTS	RPM	Secondary RPM input
	ES	Emergency stop input, normally closed
CONTROLLER	FR	Fault Reset input from Controller, or external button. This input is used to switches control back to InteliDrive Marine unit after its failure is fixed.
	WD	Isolated input for Watch dog signal, an alive indicator from InteliDrive Marine unit to I-RPU. The InteliDrive Marine unit's binary output is configured as CtrlHeartBeat and I-RPU uses it its alternation as alive indicator.
	RPU	Alive indication from I-RPU. Output is set to 1 if I-RPU is alive, 0 if in faulty state or power off InteliDrive Marine unit's binary input 7 has Warning protection in default configuration to indicate the RPU failure.
CU	FS	Fuel solenoid input from InteliDrive Marine unit. If the InteliDrive Marine is operational the signal is bypassed through I-RPU.
	SS	Stop solenoid input from InteliDrive Marine unit. If the InteliDrive Marine is operational the signal is bypassed through I-RPU.
ENG	FS	Fuel solenoid output to ENG. Low side switch (controller switches output to negative power supply terminal). If InteliDrive Marine is operational the signal is bypassed through I-RPU. If InteliDrive Marine is not operational, the RPU is controlling the output.
	SS	Stop solenoid input from CU. Low side switch (controller switches output to negative power supply terminal). If InteliDrive Marine is operational the signal is bypassed through I-RPU. If InteliDrive Marine is not operational, the RPU is controlling the output.
-	POWER1	Primary battery
	POWER2	Secondary battery
	OST	Overspeed Test button – see description in Features part
	RESET	Hard reset of RPU button – see description in Features part
	STATUS	LED indicators

LED indicators

LEDs are used for indication of InteliDrive Marine unit functionality

Group	LED colour	Description
CU	Green LED	Blinking when the InteliDrive Marine is operational and the signals are bypassed from InteliDrive Marine through RPU to engine
	Red LED	Lightening if InteliDrive Marine has failed and the control signals are operated by RPU
	No LED lightening	if the RPU unit is not operational or connected to power supply

RPU	RPU LEDs are used for indication of RPU functionality	
	Green LED	Lightening when the RPU is operational
	Red LED	Lightening if the RPU has power but is NOT operational
	No LED Lightening if the RPU is NOT connected to power supply	
ENG	LEDs are used for indication in case the RPU is controlling the engine while IntelliDrive Marine failure	
	Green LED	Lightening when the engine can be started
	Red LED	Lightening when RPU is stopping the engine

Example of wiring

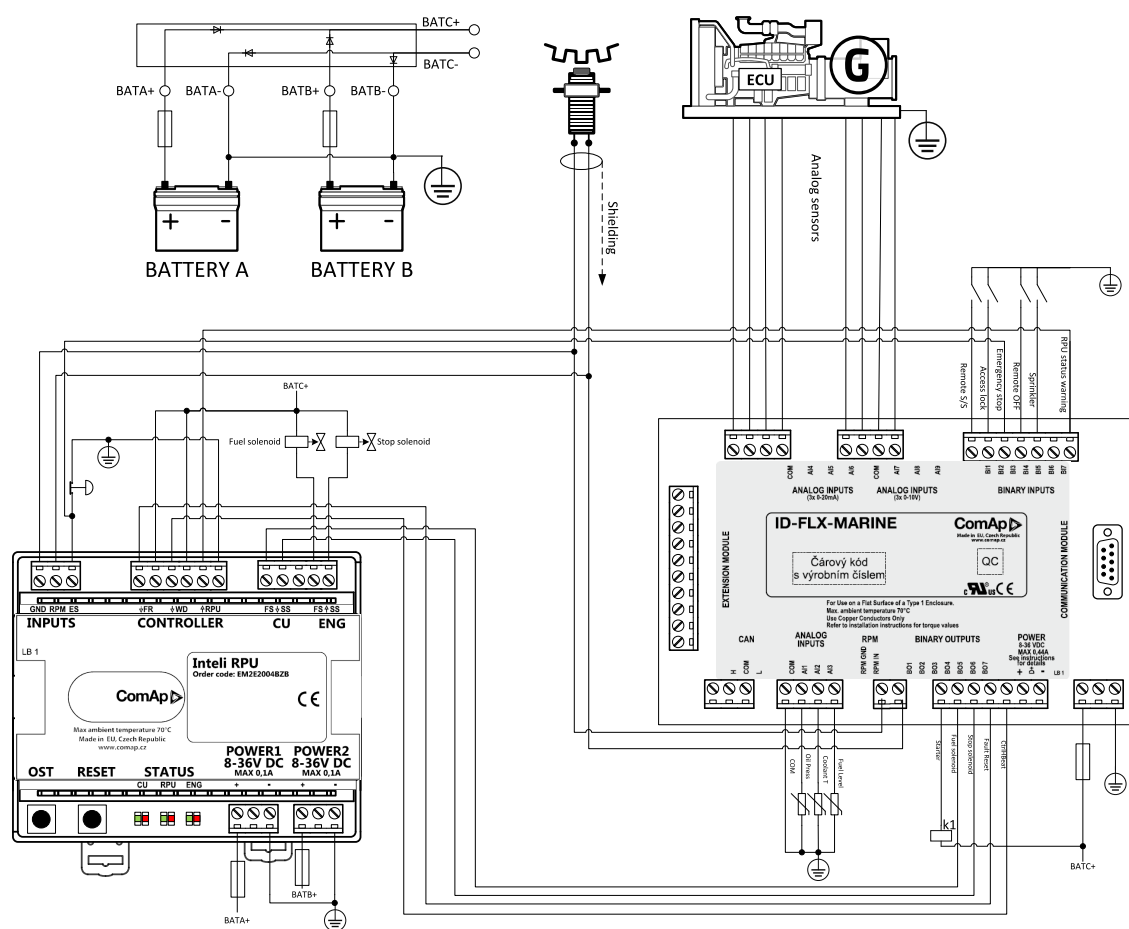

For correct functionality of Intel RPU shall be connected

- Inputs
 - Secondary RPM
 - Emergency stop button
- Controller
 - ↓FR (Fault reset) – binary output from IntelliDrive Marine unit configured as Fault Reset
 - ↓WD (Watch Dog) – binary output from IntelliDrive Marine unit configured as CtrlHeartBeat
 - ↑RPU – Binary input of IntelliDrive Marine unit with configured Warning protection to indicate RPU failure

- > CU
 - » ↓FS – Fuel Solenoid – binary output from IntelliDrive Marine unit configured as Fuel Solenoid
 - » ↓SS – Stop Solenoid – binary output from IntelliDrive Marine unit configured as Stop Solenoid
- > ENG
 - » ↑FS – Fuel Solenoid
 - » ↑SS – Fuel Solenoid
- > POWER1 and POWER2
 - » Two independent power supplies 8 .. 36 VDC

4.16.2 Features

Dual Power supply

The unit can be supplied from two independent power supplies which ensures RPUs functionality in case of one of the power supplies' failure.

Note: Both power supplies have to be in range of 8 .. 36 VDC. Maximal current for 8 VDC is 0,1 A.

Self diagnostic

The RPU unit self diagnostic feature based on Watch Dog to indicate failure or missing power of the RPU. Indication of RPU failure is done by:

- > Binary output RPU which can be connected to binary input of IntelliDrive Marine unit and used for further signalisation
 - » If the RPU unit is operational the output is active
 - » In case of RPU failure the RPU output is not active
- > Status LED - RPU
 - » Lightening green when the RPU is operational
 - » Lightening RED if IntelliDrive Marine unit has failed and the control signals are operated by RPU
 - » NO LED is lightening if the RPU has no power

IntelliDrive Marine unit failure detection

Ctrl Heart Beat Binary Output from IntelliDrive Marine is connected to binary input WD of Intelli RPU.

Required CtrlHeartBeat rate is 100ms : 100ms

If the signal connected to WD is pulsing, the IntelliDrive Marine unit is considered as operational. In this case the RPU is not taking control, only bypassing the binary signals Fuel Solenoid and Stop Solenoid to the Engine.

If the signal connected to WD input is NOT pulsing, the IntelliDrive Marine unit is considered as NOT operational and the RPU takes over control over the engine.

RPU engine control while failure of IntelliDrive Marine unit

At the moment the RPU takes control over engine it keeps the outputs Fuel Solenoid and Stop Solenoid at their original levels before the time of failure of IntelliDrive Marine unit.

- > The RPU stops the engine in case
 - » Engine RPM exceeds configured Overspeed (Overspeed RPM configuration)
 - » Emergency stop input is deactivated (active when conneted to bat-)
 - » At this situation
 - Stop solenoid is switched to 1
 - Fuel solenoid switched to 0
 - Status red LED diode ENG is lightening
- > The RPU allows new start of engine in case
 - » Engine RPM = 0
 - » Emergency stop input is active
 - » 10 second delay has expired after the previous conditions were met
 - » At this situation
 - Stop solenoid output is set to 0
 - Fuel solenoid output is set to 1
 - Status green LED diode ENG is lightening

Returning the control back from RPU to InteliDrive Marine unit

When the InteliDrive Marine unit is back in operation it is possible to switch back to its control by

- > Pressing Fault Reset button on the InteliDrive Marine unit – Fault reset Binary output or External switch has to be connected to FR input of Inteli RPU.
- > Pressing Reset button on Inteli RPU

Overspeed test

By pressing OST button the RPU Overspeed Test is performed. The behavior is same as in case of a real issuing of overspeed protection. Engine is stopped as described in Feature “RPU engine control while failure of InteliDrive Marine unit”.

Note: For the Overspeed Test the RPU has to be controlling the engine (InteliDrive Marine has to be switched off) and the engine has to be running.

Note: Overspeed test is issued by setting the overspeed protection RPM to half of the value configured by dip switches.

4.16.3 Overspeed RPM configuration

Overspeed RPM protection is configured by switching dip switches SPEED PRESET and TIME BASE according to following instructions.

- > Step 1

Use following formula to calculate value X:

$$X = (\text{RPMover} \times \text{Gear teeth}) / 60$$

- > Step 2

According to value X calculated in step 1 select DIP TIME BASE configuration and value C to be used in step 3 from following table:

X range	C	Time base
2016 to 8128	32	0001
504 to 2032	8	0010
126 to 508 2 0100	2	0100
1 to 127	0,5	1000

> Step 3

Use following formula to calculate value N.

$$N = X/C + 1$$

Value N converted from Dec into Binary is final configuration of Speed Preset DIP switches.

Example of wiring

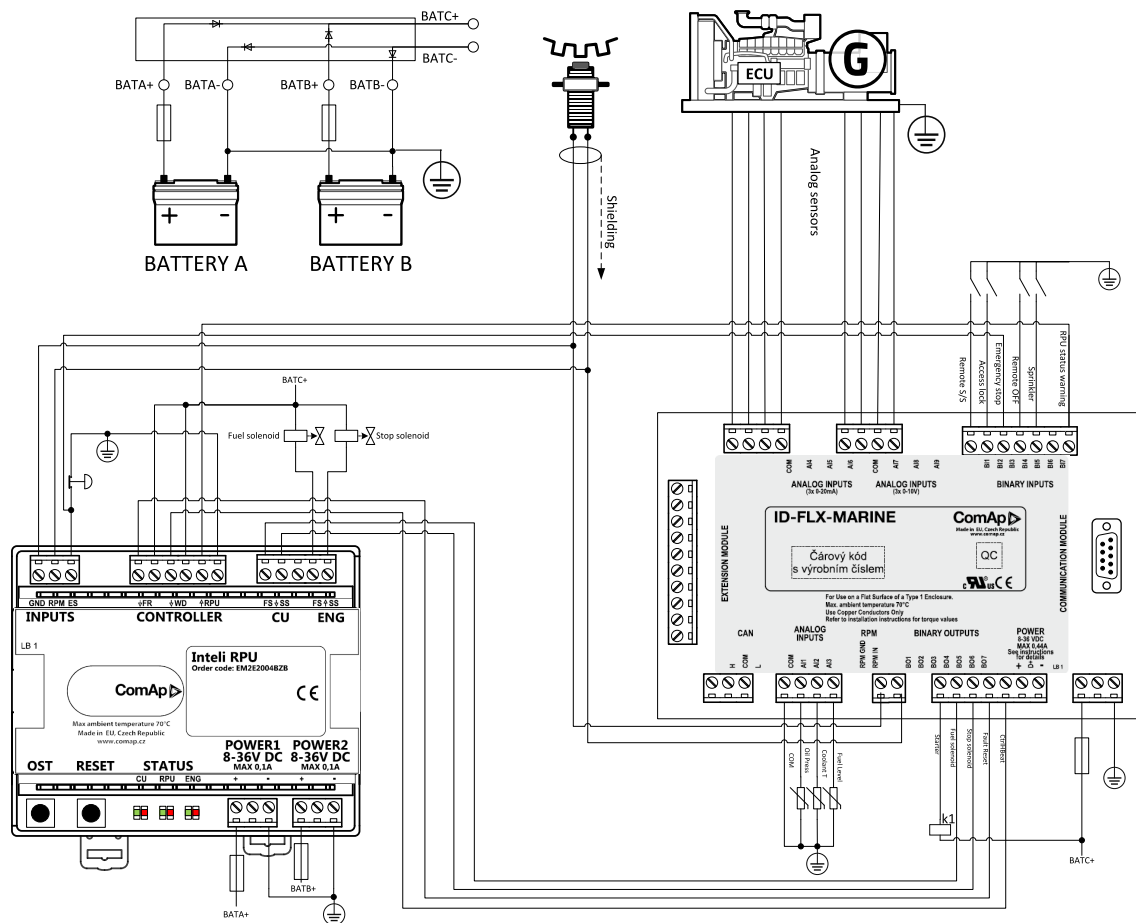

For correct functionality of Intel RPU shall be connected

> Inputs

- » Secondary RPM
- » Emergency stop button

> Controller

- » ↓FR (Fault reset) – binary output from IntelliDrive Marine unit configured as Fault Reset
- » ↓WD (Watch Dog) – binary output from IntelliDrive Marine unit configured as CtrlHeartBeat

- » ↑RPU – Binary input of IntelliDrive Marine unit with configured Warning protection to indicate RPU failure
- > CU
 - » ↓FS – Fuel Solenoid – binary output from IntelliDrive Marine unit configured as Fuel Solenoid
 - » ↓SS – Stop Solenoid – binary output from IntelliDrive Marine unit configured as Stop Solenoid
- > ENG
 - » ↑FS – Fuel Solenoid
 - » ↑SS – Fuel Solenoid
- > POWER1 and POWER2
 - » Two independent power supplies 8 .. 36 VDC