

Automatic Transfer Switch

Instruction

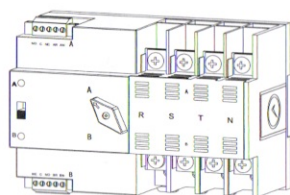

1 Overview

- Series dual power automatic transfer switches are newly developed miniature household power transfer switches. This switch is mainly used to test whether the normal or standby power supply is normal. When the normal power supply is abnormal, the backup power supply will work immediately to ensure the continuity, reliability and safety of the power supply. This product is specially designed for home track TV installation and is specially used for Pz30 distribution box.
- Series of automatic transfer switches are suitable for emergency power system 400v, 60A with AC rated current of 50v or 60Hz, compact structure, reliable conversion, easy installation and maintenance. long life. It is widely used in various occasions where continuous power failure is not allowed. It can be operated electrically or manually by ATS, and the controller.
- Complies with requirements of Low-voltage Switch Gear and Control Gears specified by IEC 60947-6-1 and IEC60947-3: functional equipment and transfer switch equipment

2 Product Model and Classification

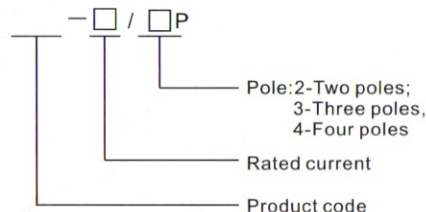

3 Basic Parameters

See Table 1 for the basic parameters of

Table 1

Rated current Ie A	16 20 25 32 40 50 63	100
Insulation voltage Ui	AC 690V	
Rated voltage Ue	AC 400V	
Grade	Grade PC:able to male and withstand, not to break short-circuit current	
Use category	AC-33iB	
Pole	2P	3P 4P
Weight(kg)	0.62	0.72 0.81
Life	Electrical:2000times;Mechanical:5000times	
Rated conditional short-circuit current Iq	50kA	
SCPD (fuse)	RT16-00-63A	
Rated impulse withstand voltage	8kV	
Control circuit	Rated control voltage Us:AC220V, 50Hz Correct working condition85%Us~110%Us	
Auxiliary circuit	AC220V/AC110V 50/60Hz	
Contact transfer time	< 50ms	
Operating transfer time	< 50ms	
Return transfer time	< 50ms	
Off-time	< 50ms	
Temperature range	-5℃~+40℃ average temperature not more than 35℃ in 24 hours	

4 Normal working conditions and installation conditions

- Ambient temperature: the upper limit does not exceed + 40°C. The average value of 24h does not exceed + 35°C, and the lower limit is not lower than -5°C.
- The altitude is higher than the installation site and the altitude does not exceed 2000m.
- When the highest atmospheric temperature is +40°C, the relative humidity of the atmosphere at the installation site should not exceed 50%. At lower temperatures, higher relative humidity is allowed, for example, temperature + 25°C, relative humidity is 90%. Due to temperature changes, occasionally measures should be taken to prevent condensation on the surface of the product.
- Pollution degree The pollution degree of TSE complies with the level 3 specified by IEC. The installation category of 60947-6-1 and IEC 60947-34.5 installation category TSE conforms to the category specified by IEC 60947-6-14.6. Installation conditions can be installed vertically in a control cabinet or power distribution cabinet. Make sure: the installation distance S is as shown in the figure. 1 ...

5 matters needing attention

- Manual/automatic operation can ensure the on and off performance in electrical operation, but in manual operation, it cannot be guaranteed due to the difference in the operator's on and off speed. In manual operation, excessive silver alloy loss may occur. Therefore, only after cutting off all power to check and maintain the operating system and contact information, can the selector switch be pulled to the manual position. Normally, please pull the selector switch to the electric position. When manual operation is required, pull the selector switch to the manual position. After the manual operation is completed, pull the selector switch from the manual position to the automatic position.
- The control circuit TSE is excited instantly. After the conversion is completed, the internal switch will damage the coil in the control circuit. The coil can work normally at 85%-110% of the rated working voltage. Too low input voltage may cause the coil to heat up and burn.

6 Installation and wiring

- Before installation and wiring, please ensure that professionals have read this manual.
- Before installation, please check the integrity of the ATS. Then turn on the ATS with operating handle, check the flexibility of the operating mechanism, and check the on and off status of each phase and the load of the normal and alternative power sources.
- The nameplate of the product can be seen from the front. If you fail to install in the specified direction due to wiring or other reasons, please contact us. The safety distance S1, S2 should not be less than the distance specified in Figure 2. (More information on side picture).
- Check the control power supply voltage: 50 / 60Hz AC220V. The connecting wire of the control circuit should not be too long. The cross-sectional area of the copper wire should be greater than 2.0mm.
- Please equip the ATS with suitable circuit breakers according to the installation requirements of the power distribution system to ensure the safety of personnel and equipment.

7 Maintenance, inspection and storage

- Maintenance and inspection should be performed by professionals. Before cutting off all power supplies.
- To ensure the good performance of the ATS, the first maintenance and inspection should be carried out within 6 months after use. Then maintain and inspect at least once a year. Under severe installation conditions, the frequency of maintenance and inspection should be increased.
- If the maintenance and inspection items fail, please remove the dust. b. Please check whether the electrical contact parts are deformed and damaged, and remove the metal particles and scorch on the surface c and its surroundings. Rust, acidification and dust on the contact surface may cause poor contact, so please perform several manual operations and measure the necessary contact resistance. d. If the ATS is damp or left empty for a long time, please dry it before turning on the power. After removing the dust, use a 500V megger to measure the insulation resistance of the normal power supply and AC power supply. Load side and two poles, including insulation resistance, when using live parts and metal plates, the insulation resistance should not be less than 10MQ.
- Amphetamine-type stimulants should be stored in the same environment as normal working conditions with dust, moisture and collision avoidance measures.

Certification

Description _____

Model No. _____

Inspector _____

Date of production _____



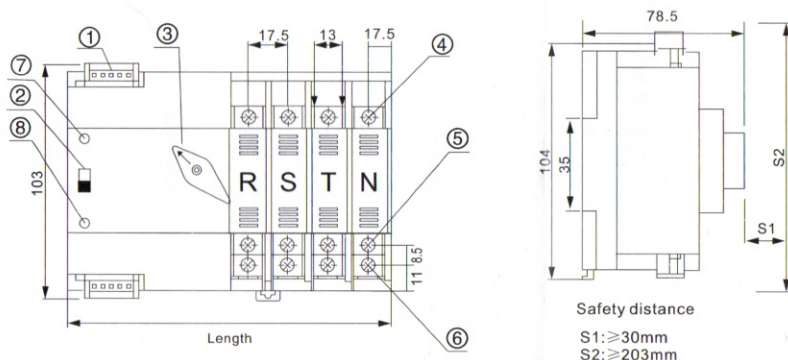
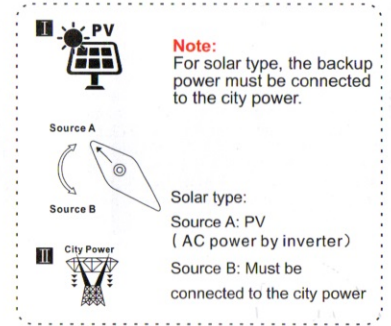
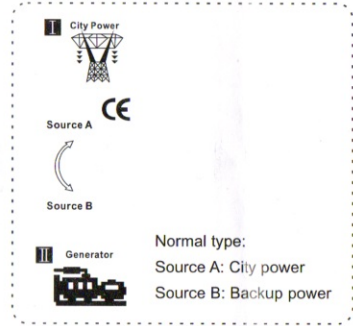

Table 2 dimensions

pole numbers	2P	3P	4P
Length	107.5	125	142.5

- ① Control power
- ② Selection switch(Auto/manual)
- ③ Manual knob
- ④ Normal power main circuit terminal
- ⑤ Alternative powermain circuit terminal
- ⑥ Load side main circuit terminal
- ⑦ Power A indicator
- ⑧ Power B indicator



Suggestion: It is best to add over-voltage and under-voltage protectors of the circuit.

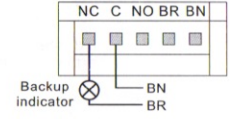
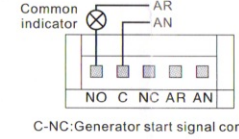

C-NC:Generator start signal contact

Rated control voltage U_s :AC220-230V;
 If the product is using under the condition of voltage less than 190V, it will burn.
 Rated control voltage U_s :AC110V;
 If the product is using under the condition of voltage less than 95V, it will burn.



Fig.1 Contour dimensions and installation dimensions

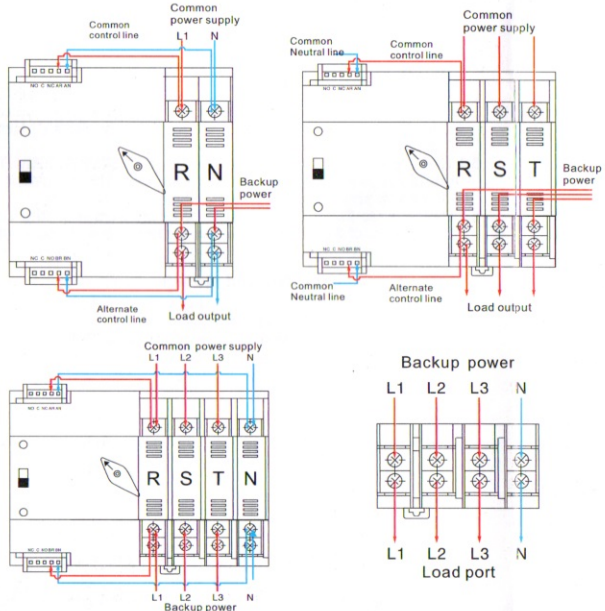

1. (Must be connected) Take zero line and fire line from the common control incoming line to connect AR (live wire) / AN (neutral line)
2. (Must be connected) Take zero line and fire line from the backup control incoming line to connect BR (live wire) / BN (neutral line)
- 3.The power indication signal is passive output, and the generator signal is taken (common) and (normally closed)
- 4.Connect the load end at the lower end of the (standby power supply side), Stepped wiring
- 5.There is an isolation board on the load. When wiring, first remove the isolation board, connect the load and then install the isolation board (it is recommended to connect the load first, then connect the backup power supply)

Note: Normal type wiring same as solar type. For solar type, the backup power must be connected to the city power.

Fig. 2Wiring diagram of controller