

# ATS 520 ATS CONTROLLER USER MANUAL



## Software Version

No.	Version	Date	Note
1	V1.0	2020-07-20	Original release.



Chongqing Mebay Technology Co.,Ltd

Add: No6-2,Building 4, Gangan Rd, Jiangbei District, Chongqing.

Tel: +86-23-6869 3061



Fax: +86-23-6765 8207

Web: <http://www.mebay.cn>

<http://www.cqmb.cn>

E\_mail: [sales@mebay.cn](mailto:sales@mebay.cn)

Symbol Description

Symbol	Description
 Note	Remind operators to operate correctly, otherwise it may cause the equipment not to work correctly.
 Be care	It is indicated that potential hazards can damage equipment without proper precautions.
 Warning	It is indicated if appropriate preventive measures are not taken, potentially dangerous situations may result in death, serious personal injury or significant property losses.

**Warning**

- 1.The installation of this equipment must be carried out by professionals.
- 2.When installing and operating the controller, please read the entire instruction manual first.
- 3.Any maintenance and commissioning of the equipment must be familiar with all the equipment.
- 4.Safety standards and precautions in advance, otherwise it may cause personal injury or damage to related equipment.
- 5.After the installation of the controller is completed, please verify that all protection functions are valid.

**Be Care**

- 1.Please keep the good connection of the power supply of the controller. Do not share the connection lines of the positive and negative electrodes of the battery with the floating charger.
- 2.During the operation of the engine, do not disconnect the battery, otherwise it may cause damage to the controller.

**Catalogue**

Summary..... 6

Main Features.....6

Parameters Display..... 7

Parameters.....8

Overall Dimension and Wiring Diagram..... 9

Installation instruction.....20

Panel and display..... 21

Generator set start/stop operation..... 23

Switch operation and ATS power control.....25

Prompt status information..... 27

Warning and fault alarm.....29

Parameter setting..... 30

Fault finding..... 39

**Notes:**

1. All rights reserved. No part of this duplication may be reproduced in any material form (including photocopying or storing in any medium by electronic means or others) without the written permission of the copyright holder.

2. MEBAY Technology reserves the rights to change the contents of this document without prior notice.

## Summary

The controller is a dual power switching ATS controller, dual power intelligent switch module with programmable, automatic measurement, automatic control and LCD display functions. Automatic measurement and control can reduce incorrect operation. It is an ideal option for ATS.

3.5inch LCD screen display with brand new UI design is adapted in this controller can display related parameters directly. The LCD screen can display various faults at the same time. Once the generator does not run normally, it can effectively achieve protection.

There are Chinese/English interface options, more language can be set according to user's request. All the parameters can be configured through the front face buttons or use programmable interface by RS485 or USB to adjust via PC. It has compact structure, advanced circuits, simple wiring and high reliability, It can be widely used in various types of power systems.

## Main Features

There are four Models under ATS520 series.

ATS 520: Dual power intelligent switch module.

ATS 520 I: Based on ATS 520, it adds power measurement function.

ATS 520 R: Based on ATS 520, it adds RS485 port.

ATS 520 IR: Based on ATS 520, it adds power measurement function and RS485 port.

- ◆ Dual core 32bit high performance single chip microcomputer.
- ◆ 3.5inch LCD screen, Available in Chinese/English languages, user's language set if necessary.
- ◆ System type can set as: "S1 Mains S2 Mains", "S1 Mains, S2 Gen", "S1 Gen S2 Mains", "S1 GenS2 Gen".
- ◆ Acrylic material is adapted to protect the screen.
- ◆ PC material panel, waterproof, oil-proof, UV-resistant, good operation feel and long service life.
- ◆ USB Port: parameters can be set even without power through USD port to monitor in real time.
- ◆ With RS485 communication port, can achieve "Three Remote" functions via MODBUS protocol.
- ◆ S1 / S2 independent overcurrent warning or trip alarm function.
- ◆ Collection and display, gen, mains, power, phase and other parameters.
- ◆ Display S1/S2 Total kW Energy, Total KVAR Energy, Total Close Times.
- ◆ For Stored-Energy type ATS, its close relay will active after the PF Input is active.
- ◆ The genset can be Manual Test on site to achieve start/stop operation.
- ◆ ATS Controller has function of automatic Re-closing.
- ◆ Applicable for PC Three-stage, PC Two-stage, CB and CC switch.
- ◆ Applicable for 2 isolated neutral line.
- ◆ Real-time clock (RTC); Event log Function (Event log can record 14 items circularly).

- ◆ Automatic/Manual mode. In manual mode, can force the switch to close or open.
- ◆ Can control two generators to work as Cycle Run mode, Master Run mode and Balance Run mode.
- ◆ Suitable for various AC systems (3 phase 4-wires, 3-phase 3-wires, single-phase 2-wire, and 2-phase 3-wire).
- ◆ Input/output function, status can be shown directly.
- ◆ Real time clock inside.
- ◆ Totally 8 relays output, 6 relays function configurable.
- ◆ Totally 6 configurable switch input, 4 switch function configurable.
- ◆ Control Protection: Realize automatic ATS switching of generator sets, perfect fault display and protection functions.
- ◆ Standard water-proof rubber gasket. The waterproof can reach IP54.
- ◆ Module design: All the connections are adapted with European connectors so that installation, connection, repair and replacement can be more easily.

### **Parameters Display**

- ◆ S1/S2 Voltage Status
- ◆ Genset Status
- ◆ Switch Status
- ◆ S1/S2 Line Voltage
- ◆ S1/S2 Phase Voltage
- ◆ S1/S2 Phase
- ◆ S1 Frequency and genset battery voltage
- ◆ S2 Frequency
- ◆ Cont. Power Supply Time
- ◆ Last Cont. Power Supply
- ◆ S1/S2 Total Supply Time
- ◆ S1/S2 Total KWH
- ◆ S1/S2 Total KVAR
- ◆ S1/S2 Total Close Times
- ◆ Total Power-on time
- ◆ Alarm number and account
- ◆ Alarm type (Warn Alarm, Fault Alarm)
- ◆ Alarm event
- ◆ Inputs, outputs number
- ◆ Input status, S1/S2 closing input, 1~4 are configurable ports
- ◆ Output status, S1/S2 closing output, 1~6 are configurable ports
- ◆ Real-time clock
- ◆ RS485 Communication
- ◆ Communication Address
- ◆ RS485 Baud Rate
- ◆ Current time

**Parameters**

Options	Parameters
Working voltage	DC 8V----36V Continuous
	AC 90V-280V(L1N1/L2N2)
Power consumption	Standby: 24V: MAX 2W
	Working: 24V: MAX 6W
AC Voltage Input	1P2W 30VAC-260VAC (ph-N)
	2P3W 30VAC-450VAC (L-L)
	3P3W 30VAC-450VAC (L-L)
	3P4W 30VAC-450VAC (L-L)
AC Voltage Input	1P2W 30VAC-260VAC (L-N)
	2P3W 30VAC-450VAC (L-L)
	3P3W 30VAC-450VAC (L-L)
	3P4W 30VAC-450VAC (L-L)
MAX Accumulating Time	99999.9Hours (Min Store time:6min)
Closing S1 output	250V/16 AMP Non-contact normally Open output
Closing S2 output	250V/16 AMP Non-contact normally Open output
Programmable Relay output 1-6	250V/5 AMP Non-contact normally Open output
Closing S1 input	Available if connecting with Battery -
Closing S2 input	Available if connecting with Battery -
Switch value input 1-4	Available if connecting with Battery -
Working condition	-25-70°C
Storage condition	-30-80°C
Protection Level	IP54: when waterproof rubber gasket is added between controller and its panel
Insulation strength	Apply AC 2.2kV voltage between high voltage terminal and low voltage terminal; The leakage current is not more than 3mA within 1min.
Overall dimension	210mm*160mm*50mm
Panel cutout	186mm*142mm
Weight	0.9Kg



Overall Dimension and Wiring Diagram

◆ Overall Dimension:

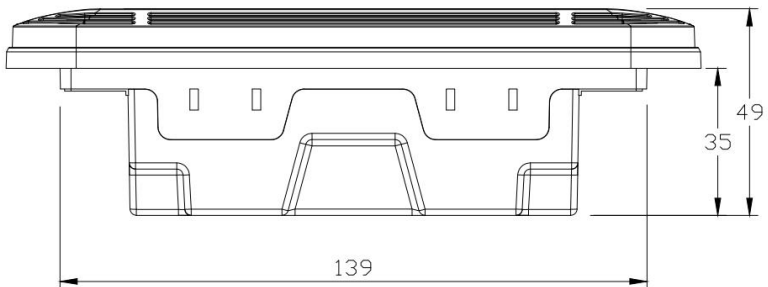
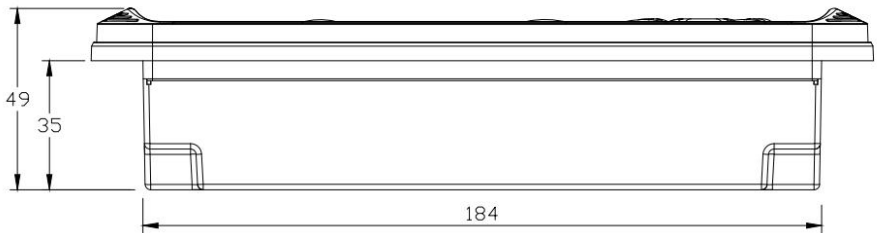

◆ **Descriptions of terminal connection**

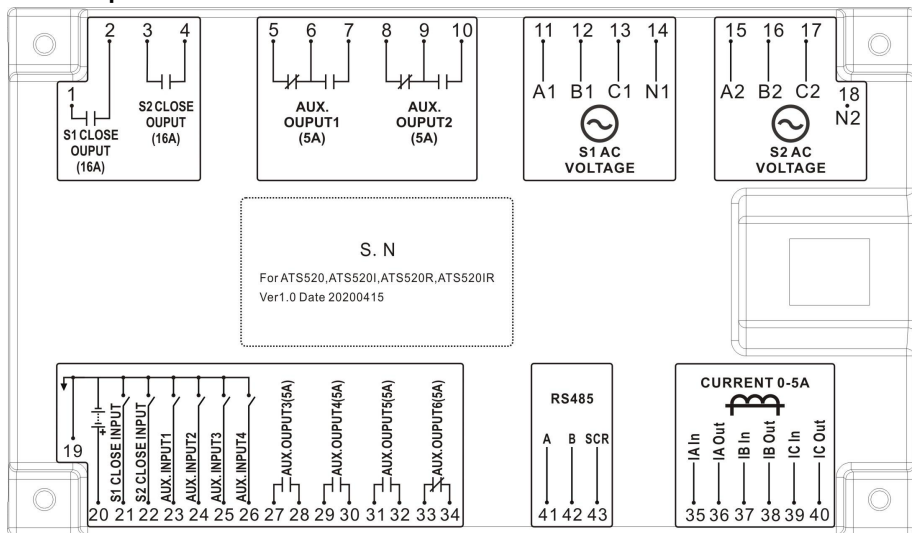

No.	Function	Description	Cable cross sectional area
1	S1 Close Output	Non-contact normally Open output Capacity: 250V/16A	2.5mm <sup>2</sup>
2			2.5mm <sup>2</sup>
3	S2 Close Output	Non-contact normally Open output Capacity: 250V/16A	2.5mm <sup>2</sup>
4			2.5mm <sup>2</sup>
5	Aux. Output 1	Normally Close	1.5mm <sup>2</sup>
6		COM	1.5mm <sup>2</sup>
7		Normally Open	1.5mm <sup>2</sup>
8	Aux. Output 2	Normally Close	1.5mm <sup>2</sup>
9		COM	1.5mm <sup>2</sup>
10		Normally Open	1.5mm <sup>2</sup>
11	A1	S1 AC System 3P4W voltage input For single phase, only connect A1, N1	1.5mm <sup>2</sup>
12	B1		1.5mm <sup>2</sup>
13	C1		1.5mm <sup>2</sup>
14	N1		1.5mm <sup>2</sup>
15	A2	S2 AC System 3P4W voltage input For single phase, only connect A2, N2	1.5mm <sup>2</sup>
16	B2		1.5mm <sup>2</sup>
17	C2		1.5mm <sup>2</sup>

18	N2		1.5mm <sup>2</sup>	
19	B-	Connected with negative of starter battery.	2.5mm <sup>2</sup>	
20	B+	Connected with positive of starter battery.	2.5mm <sup>2</sup>	
21	S1 Close Output	Detect the S1 ATS closing status, Ground connected is active.	1.5mm <sup>2</sup>	
22	S2 Close Output	Detect the S2 ATS closing status, Ground connected is active.	1.5mm <sup>2</sup>	
23	Aux. Input 1	User-defined. Ground connected is active.	1.5mm <sup>2</sup>	
24	Aux. Input 2		1.5mm <sup>2</sup>	
25	Aux. Input 3		1.5mm <sup>2</sup>	
26	Aux. Input 4		1.5mm <sup>2</sup>	
27	Aux. Output 3	User-defined. 250V/5AMP Non-contact normally Open output.	1.5mm <sup>2</sup>	
28			1.5mm <sup>2</sup>	
29	Aux. Output 4		1.5mm <sup>2</sup>	
30			1.5mm <sup>2</sup>	
31	Aux. Output 5		1.5mm <sup>2</sup>	
32			1.5mm <sup>2</sup>	
33			1.5mm <sup>2</sup>	
34	Aux. Output 6		1.5mm <sup>2</sup>	
35	IA In		CT Secondary A-Phase current input	1.5mm <sup>2</sup>
36	IA Out			1.5mm <sup>2</sup>
37	IB In	CT Secondary B-Phase current input	1.5mm <sup>2</sup>	
38	IB Out		1.5mm <sup>2</sup>	
39	IC In	CT Secondary C-Phase current input	1.5mm <sup>2</sup>	
40	IC Out		1.5mm <sup>2</sup>	
41	RS485_A+	RS485 Communication Port	1.0mm <sup>2</sup>	
42	RS485_B-	A 120 Ω shielded wire and good grounding are recommended	1.0mm <sup>2</sup>	
43	RS485_SCR		1.0mm <sup>2</sup>	
	USB-B	For PC operation and control		

### ◆ ATS520 Typical Wiring Diagram

The following is a full-function application diagram of the ATS controller series. ATS520 and ATS520R have no current sampling input. Please omit the parts related to current in the application diagram.

Auxiliary Output 6 is default set as Genset Start Output (Normally Open) and there is only normally close contact in it. The controller also can control the genset

start even if there is no power supply. If DC Power is selected, Genset Start Output port can be set as other items.

◆ ATYS3 Wiring Diagram

Parameters Setting		
1	Switch Type	PC Three-stage
2	Aux. Output 1	ATS Power L
3	Aux. Output 2	ATS Power N
4	Aux. Output 4	S1 Open Control
5	Aux. Output 6	Gen Start Output

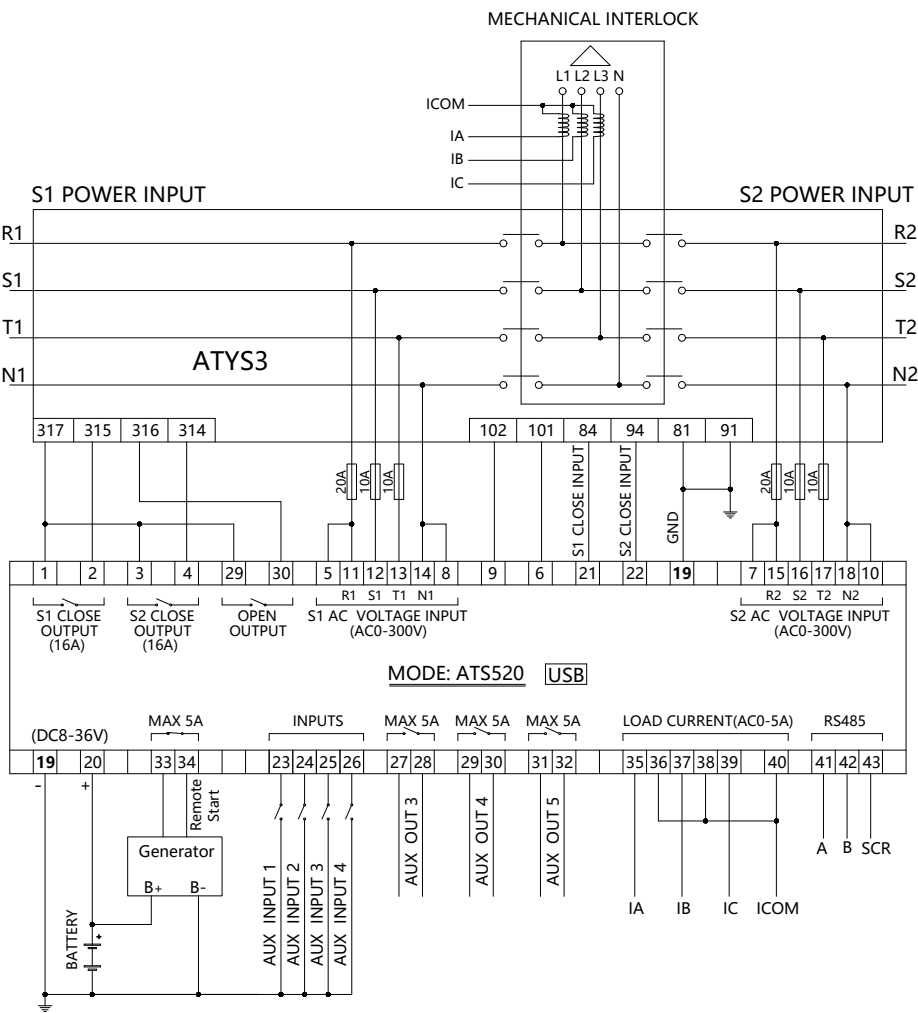

◆ SGQ-N/T Wiring Diagram

Parameters Setting		
1	Switch Type	PC Two-stage
2	Aux. Output 1	ATS Power L
3	Aux. Output 2	ATS Power N
4	Aux. Output 6	Gen Start Output

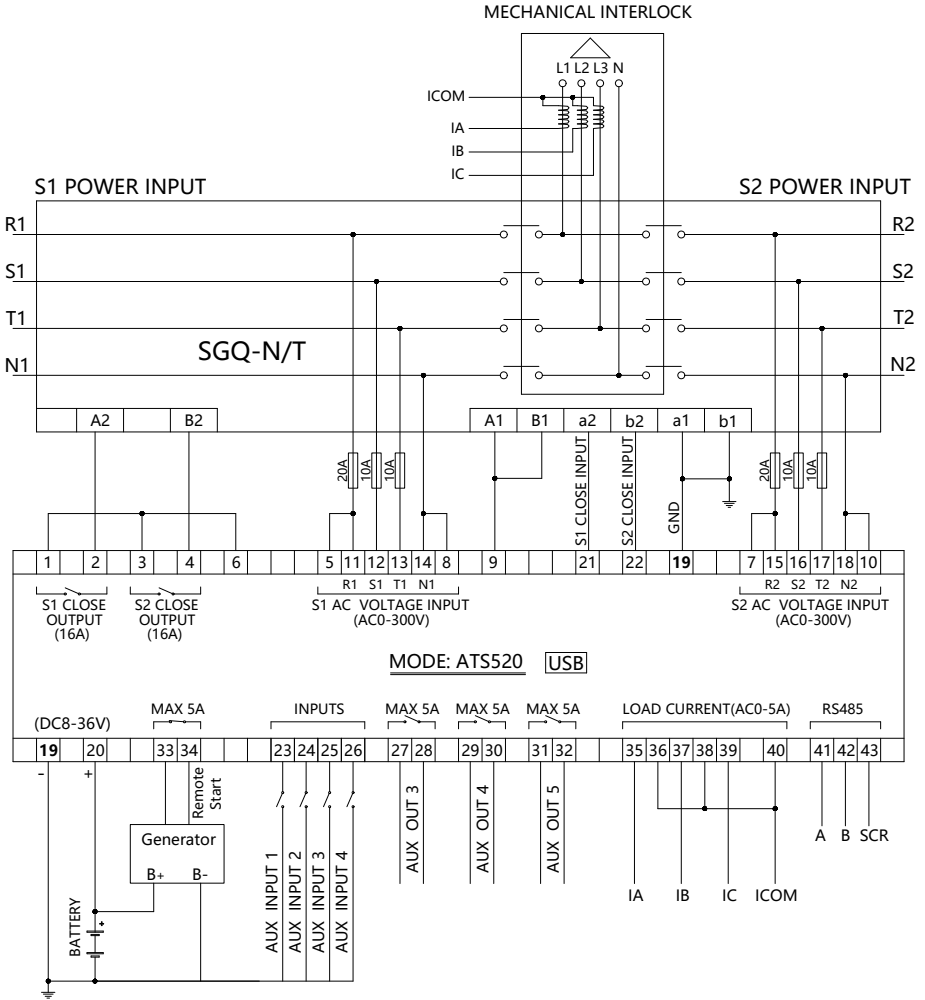

◆ SGQ-M Wiring Diagram

Parameters Setting		
1	Switch Type	PC Two-stage
2	Aux. Output 1	ATS Power L
3	Aux. Output 2	ATS Power N
4	Aux. Output 6	Gen Start Output

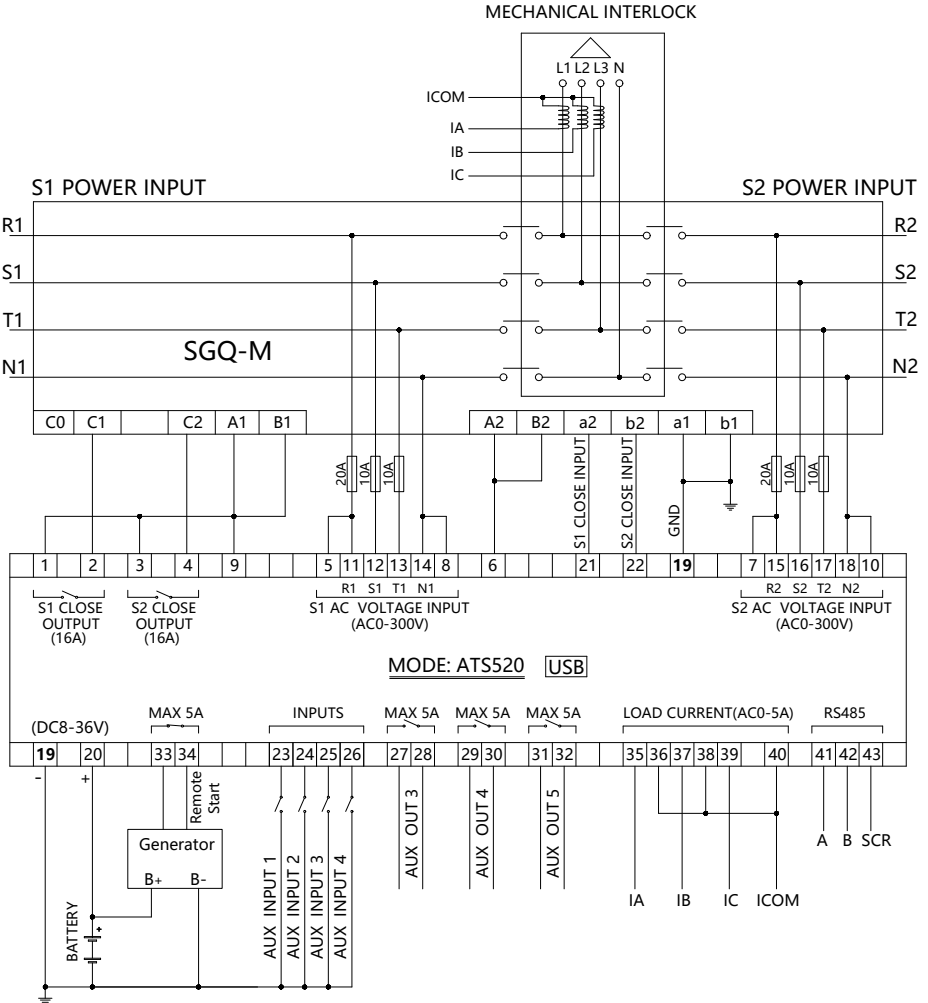

◆ VITZRO/PHETENG Wiring Diagram

Parameters Setting		
1	Switch Type	CB/CC
2	Aux. Output 1	ATS Power L
3	Aux. Output 2	ATS Power N
4	Aux. Output 4	S1 Open Control
5	Aux. Output 5	S2 Open Control
6	Aux. Output 6	Gen Start Output

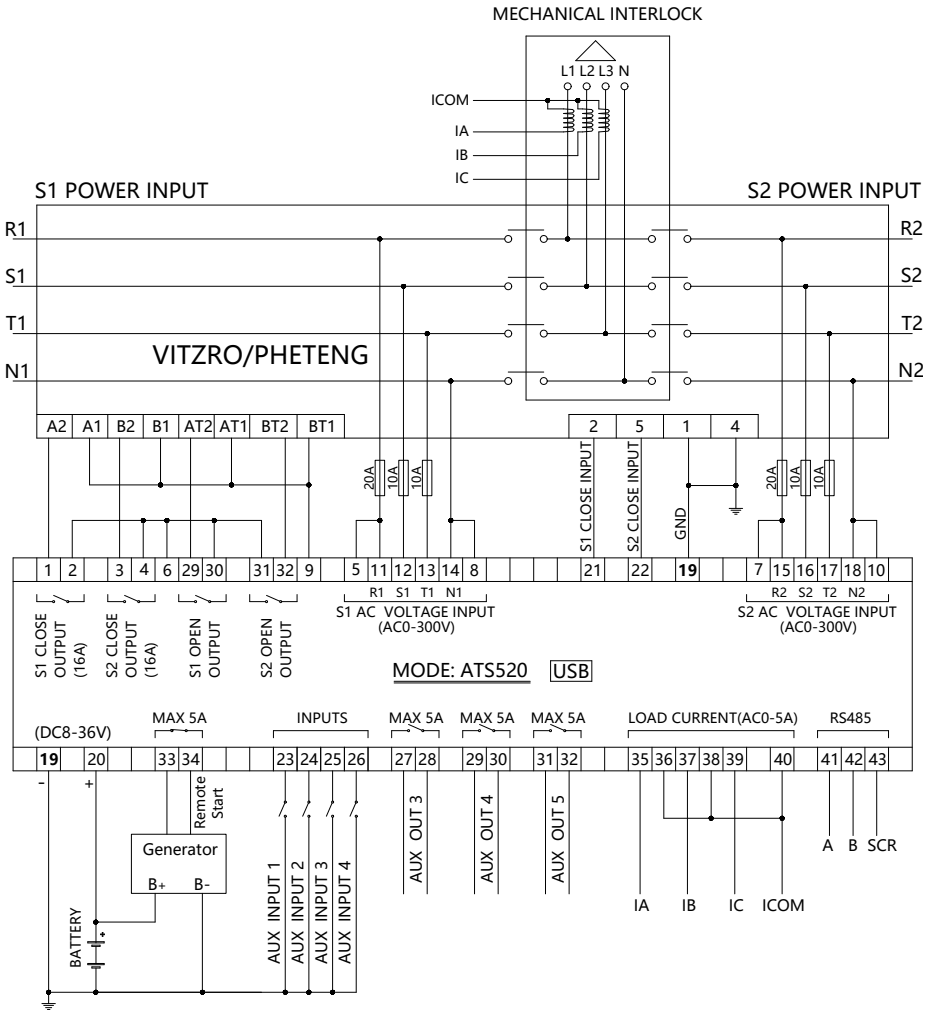

◆ Contactor Wiring Diagram

Parameters Setting		
1	Switch Type	CB/CC
2	Aux. Output 6	Gen Start Output
3	Continuously Close	1-Enable

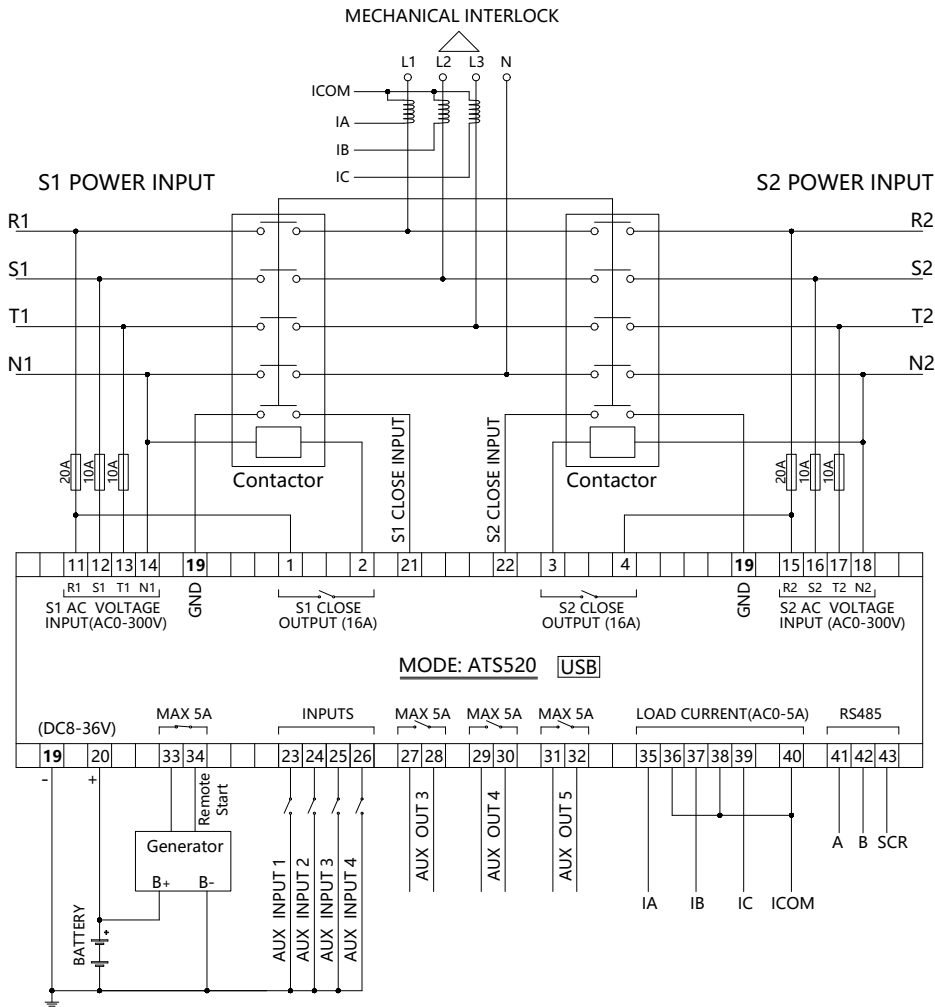



◆ ATYSM3S Wiring Diagram

Parameters Setting		
1	Switch Type	PC Three-stage
2	Aux. Output 1	ATS Power L
3	Aux. Output 2	ATS Power N
4	Aux. Output 4	S1 Open Control
5	Aux. Output 6	Gen Start Output

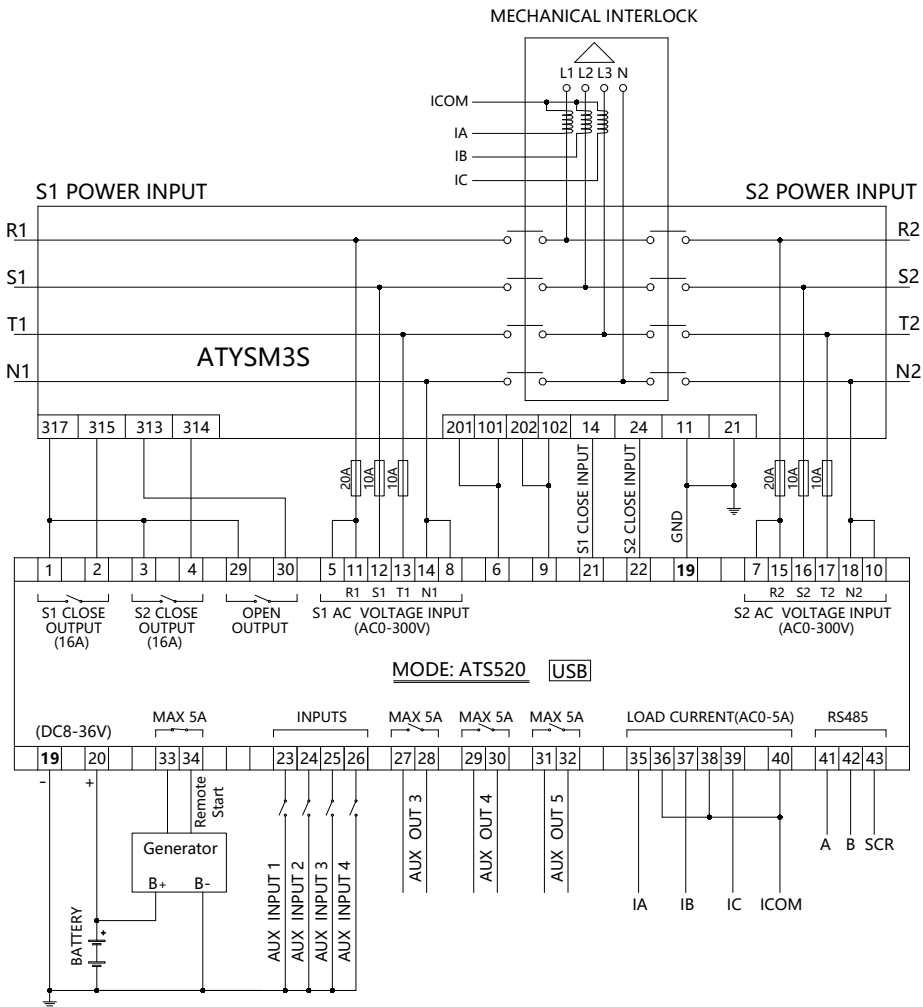

◆ Breaker Wiring Diagram

Parameters Setting		
1	Switch Type	CB/CC
2	Aux. Output 4	S1 Open Control
3	Aux. Output 5	S2 Open Control
4	Aux. Output 6	Gen Start Output
5	MCH:Stored Energy Motor; MN:Under Voltage Trip; MX:Open Relay;XF:Close Relay;	

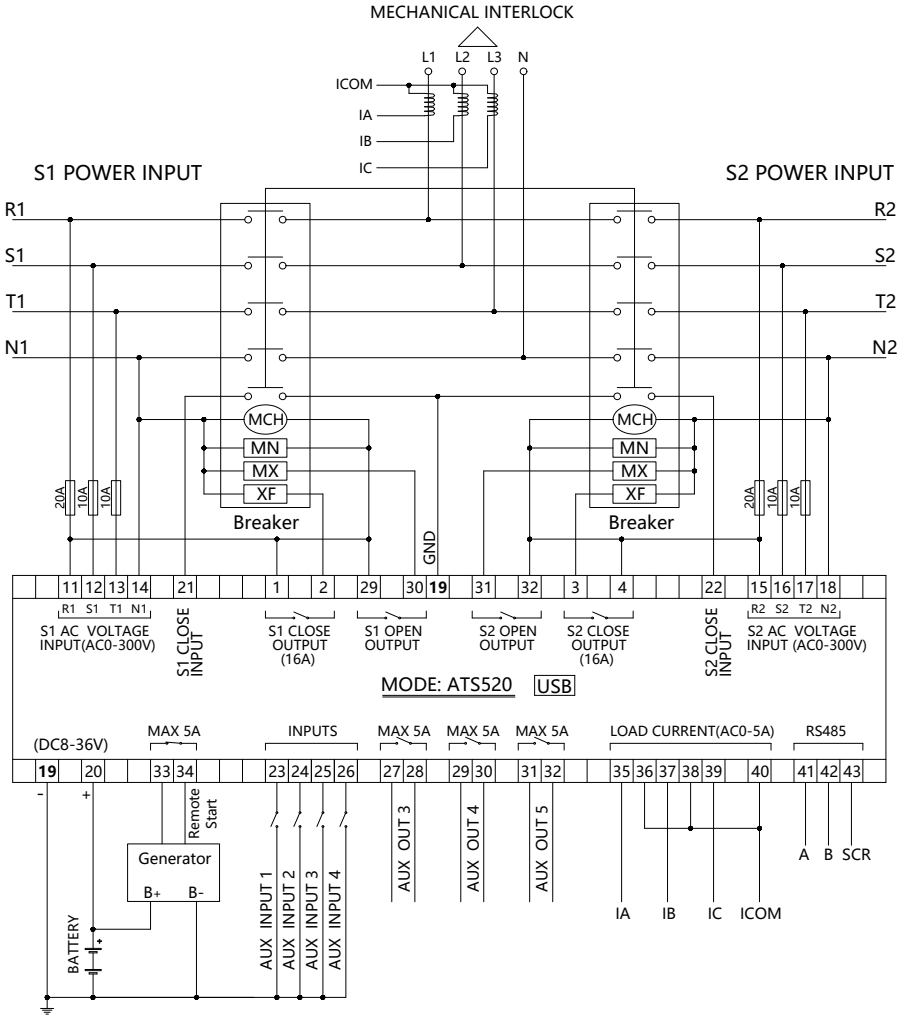

◆ ASCO Series 230 RTS Wiring Diagram

Parameters Setting		
1	Switch Type	PC Three-stage
2	Aux. Output 1	ATS Power L
3	Aux. Output 2	ATS Power N
4	Aux. Output 4	S1 Open Control
5	Aux. Output 6	Gen Start Output

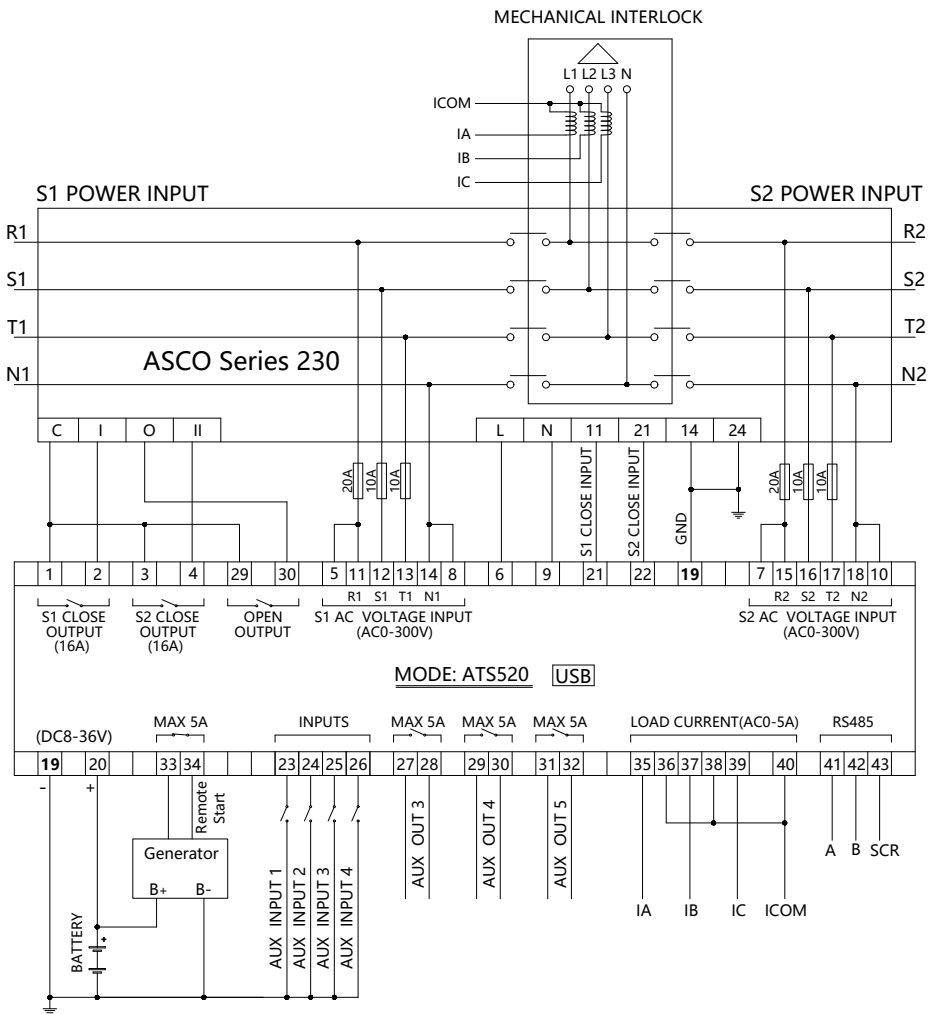

**WARNING:** When generator is on-load, C. T. secondary must not be open circuit, Otherwise, the high voltage generated will pose a danger to personal safety.

**Installation instruction**

- ◆ The controller is fixed by four special fixing members and screws, and the screws of the metal fasteners cannot be too tight.
- ◆ Panel Cutout: W186mm\*H142mm.

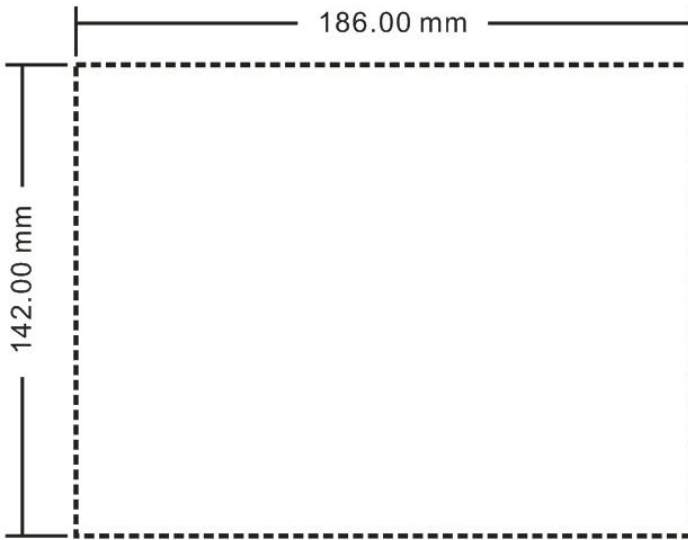

**Note:** If the controller is installed directly in the genset shell or other fluctuated equipment, the rubber pad must be installed.

◆ **Battery Voltage Input**

ATS 520 controller is suitable for 8-36V DC battery voltage. Battery negative must be reliably connected to the enclosure of the engine. The controller power supply B+ and B- must be connected to battery positive and negative, and the wire size must not be less than **2.5mm<sup>2</sup>**.



**NOTE:**

In case of floating charger connect charger output to battery positive and negative directly, then, connect battery positive and negative poles to controller positive and negative power supply.

◆ **Output and relay expansion**



**Note:** All outputs of the controller are relay contacts. The maximum current capacity is described in the "Parameters" in this manual. Please use it in the relay current capacity. If an extended relay is needed, add a continuous current diode (when the extended relay coil is DC) or a resistance-capacitance loop (when the extended relay coil is AC) to both ends of the coil to prevent interference with the controller or other equipment.

◆ AC current input

Current transformer with rated secondary current **5A** must be externally connected to the controller current input.



**WARNING:** When generator is on-load, C. T. secondary must not be open circuit, Otherwise, the high voltage generated will pose a danger to personal safety.

◆ Withstanding voltage test



If withstanding voltage test is conducted after the controller has already been installed onto the control panel, please unplug all controller terminal connections in order to prevent high voltage from damaging it.





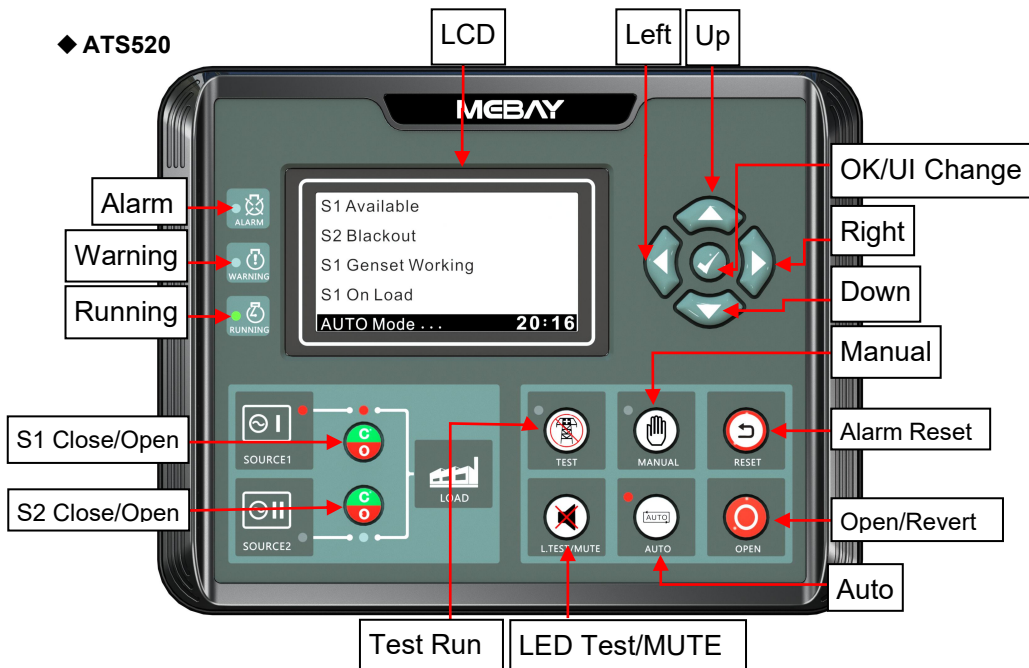







**Panel and display**



◆ **ATS520**



◆ **Key Function Description**









KEYS	NAME	Main Function
	Open/ Revert	<ul style="list-style-type: none"> <li>◆ Under running status. Press this key to stop the generator set and operate all partial brakes;</li> <li>◆ Pressing this key can cancel the setting and back to upper class under edition.</li> <li>◆ Under the setting mode with checking data, the data can be saved and system will exit after pressing.</li> </ul>

 ALARM/RESET	Alarm Reset	◆ Press this key to enter into alarm interface; Pressing it again can clear fault alarm.
 MANUAL	Manual	◆ Pressing this key will set the module into manual mode.
 AUTO	Auto	◆ Pressing this key will set the module into auto mode.
	S1 Close/Open	◆ Active in Manual mode. Press this key, if S1 load is opened, then the S1 closing relay will be energized; if S1 load is closed, then the S1 opening relay will be energized.
	S2 Close/Open	◆ Active in Manual mode. Press this key, if S2 load is opened, then the S2 closing relay will be energized; if S1 load is closed, then the S2 opening relay will be energized.
 TEST	Test Runt	◆ Press this key to enter into genset manual start/stop operation interface.
 L.TEST/MUTE	LED Test/ Warning clear	◆ Test if all LED lights are ok, pressing this key to test if all lighted, all off when loosen it. ◆ Under warning, pressing this key can clear warning and controller will re-check warning. ◆ Under alarm, pressing this key can clear the buzzer call. ◆ Pressing this key in 3 seconds can clear the buzzer call, pressing it again in 3 seconds can recover the buzzer call.
	Left	◆ Under display mode, pressing this key to turn left page. ◆ Under edition mode, pressing this key to move the digit.
	Right	◆ Under display mode, pressing this key to turn right page. ◆ Under edition mode, pressing this key to move the digit.
	Up	◆ Under display mode, parts of the page can move up. ◆ Under edition mode, pressing this key to move the digit or increase the numbers. ◆ Under records mode, pressing this key to move the digit.
	Down	◆ Under display mode, parts of the page can move down. ◆ Under edition mode, pressing this key to move the digit or decrease the numbers. ◆ Under records mode, pressing this key to move the digit.
	OK UI Change	◆ Confirm the change under edition mode. ◆ Page exited under records checking mode. ◆ Black UI and white UI can be switched when Pressing. ◆ In standby state, press for 3 seconds to enter the parameter setting mode.

 +  OPEN/ESC	Setting mode	◆ Pressing OK and STOP simultaneously to come into setting mode
---	--------------	---

**◆ Alarm records checking**

ATS520 controller can save 14 group of alarm records which contains the alarm record data includes detailed data such as alarm time, prompt status information, etc. How to check the alarm records:



- 1) Enter alarm record page: press  and  simultaneously to come into alarm records page;
- 2) Press  to turn upper digit and press  to turn lower digit in order to choose the record you need. Press  to confirm the record and come into history records checking page.
- 3) Press  to turn lower records under records checking page. Press  to turn upper records and press  to revert back to alarm history records page.
- 4) Exit from records page: In the history records page and checking page, press  to exit.

**◆ LED Indicators description**

Indicator Type	Description
Alarm	◆ Lights red when a fault alarm occurs.
Warning	◆ Lights yellow when a warning alert occurs.
Running	◆ Green during normal operation.
S1 Power Normal	◆ The S1 power is always green when the power is normal, the S1 power is red when the power is abnormal, and the S1 power is off when there is no voltage.
S1 Close Status	◆ It is light on when S1 close input is activated.
S2 Power Normal	◆ The S2 power is always green when the power is normal, the S2 power is red when the power is abnormal, and the S2 power is off when there is no voltage.
S2 Close Status	◆ It is light on when S2 close input is activated.
Test Mode	◆ It is light on when the module is in Test mode.
Manual Mode	◆ It is light on when the module is in Manual mode.
Auto Mode	◆ It is light on when the module is in Auto mode.

**Generator set start/stop operation**

**Panel start/stop**

In the main screen, press  key will enter into manual start operation interface. Press  key to choose parameters (the current line was highlighted with black) and then press Confirm key to confirm.

<b>1. Return</b>	
2. Stop Genset	Disconnect the start signal, i.e. stop the running genset.
3. Start Genset	Output the start signal, i.e. start the genset.

When system is "S1 Gen S2 Gen", manual start/stop menu interface is as follows:

Press key to choose parameters (the current line was highlighted with black) and then press Confirm key to confirm.

<b>1.Return</b>	
2.S1Stop Genset	Disconnect the S1 start signal, i.e. stop the running S1 genset.
3.S2 Start Genset	Output the S1 start signal, i.e. start the S1 genset.
4.S1Stop Genset	Disconnect the S2 start signal, i.e. stop the running S2 genset.
5.S2 Start Genset	Output the S2 start signal, i.e. start the S2 genset.

### Remote start/stop

Send remote start/stop signals using MODBUS protocol via RS485 port.

Remote Stop: Disconnect the start signal, i.e. stop the running genset.

Remote Start: Output the start signal, i.e. start the genset.

### Auto start/stop

#### Input port start/stop operation

Set input port as "Remote Start On Load" or "Remote Start Off Load", both could not be set simultaneously.

Remote Start on Load: When the input is active, genset close relay will active after genset is normal; when the input inactive, genset will stop automatically.

Remote Start off Load: When the input is active, mains close relay will active after mains is normal; genset close relay will active when the mains is abnormal while genset is normal; when the input inactive, genset will stop automatically.

### "S1 GEN S2 GEN" start/Stop

When system is "S1 Gen S2 Gen", input port start/stop function is as follows:

Remote Start on Load: Detect S1 or S2 start output according to start mode. Genset close relay will active after genset is normal.

Remote Start off Load: Detect S1 or S2 start output according to start mode. Both genset S1 close relay and S2 close relay are deactivated after genset start.

S1,S2 Gens Start Type: Cyclic Run, Master Run, Balance Run.

### Cycle Run Start:

When remote start is active, S1 and S2 cycle run start according to the cycle run time.

At the first time to start the genset, choose "S1 Start" or "S2 Start" depends on the "Master Set" information. e.g. S1 start at the first time if "S1 Master" is selected. The S1 cycle run countdown is started according to the preset delay. At the same time, genset fault delay will be initiated. If S1 genset is normal before the fault delay has expired, S1 will take load; S2 start after the preset S1 cycle run delay has expired and the S2 loading process is same as S1. S1 will stop automatically after the S2 has take load successfully. S1 and S2 will cycle run in this way alternately until the remote start signal deactivated.



During the start process, if there is genset fault alarm (genset fault delay overtime or genset fault input is active), fail to close or load inhibit alarm occurs, the starting genset will be stop immediately and the additional genset will be start automatically. During the cycle run process, if "Auto Mode" is selected, the current status will be hold and the "cycle run countdown" will be suspended.

### Master Run

Master genset will be start when remote start signal is active. During the start process, if there is genset fault alarm (genset supply delay overtime or genset fault input is active), fail to close or load inhibit alarm occurs, the starting genset will be stop immediately and the additional genset will be start automatically. Otherwise, the master run genset will running continuously until the remote start signal deactivated.

### Balance Run

The gensets which has the shortest running hours will be start when remote start signal is active. During the start process, if there is genset fault alarm (genset supply delay overtime or genset fault input is active), fail to close or load inhibit alarm occurs, the starting genset will be stop immediately and the additional genset will be start automatically. Otherwise, the current genset will running continuously until the remote start signal deactivated.



### In system "S1 Gen S2 Gen" to start/stop genset should meet following several conditions:

- 1) It is active in Auto mode;
- 2) System set as "S1 Gen S2 Gen";
- 3) Output port should be set as "S1 Genset Start" and "S2 Genset Start";
- 4) Input port should be set as "S1 Genset Fault Input", "S1 Genset Fault Input" and "Remote Start On Load" or "Remote Start Off Load";
- 5) Should set start mode when "S1 Gen S2 Gen" system is selected;
- 6) Should configure setting "Genset Supply Delay", If start mode is cycle run, also should set "S1 Cycls Run Time" and "S2 Cycls Run Time";



 Among input ports, "S1 Genset Fault Input" and "S2 Genset Fault Input" are selective setting, Genset fault can be judged by "Genset Supply Delay" and there no need to inquire the fault alarm via input port. When S1, S2 start type configured as "Not Used", there is no start genset signals output

### Switch operation and ATS power control

Manual mode is selected by pressing the  button; a LED besides the button will illuminate to confirm the operation.

Press S1  button, S1 close relay will active, after the close delay has expired, S1 close relay will deactivated and the S1 take load. Press S1  button again (Invalid

for the ATS without Open Control), S1 open relay will active, after the open delay has expired, S1 open relay will deactivated and the S1 off load.

Press S2  button, S2 close relay will active, after the close delay has expired, S2 close relay will deactivated and the S2 take load. Press S2  button again (Invalid for the ATS without Open Control), S2 open relay will active, after the open delay has expired, S2 open relay will deactivated and the S2 off load.

**Automatic operation**

Auto mode is selected by pressing the  button; a LED besides the button will illuminate to confirm the operation. The controller will select S1 power or S2 power according to the preset "master set" and control the genset to start according to the preset conditions.

**ATS Power supply**

Switch Power Type can be set as DC Power or AC Power. If DC Power is selected, then the switch can be transferred at any time (even when both S1 and S2 are outage). If AC Power is selected, whether the power is normal or not should be judged according to the ATS power setting and AC power voltage. The power of ATS is supplied by controller, as long as one power is normal, this can ensure ATS voltage power supply normally and can be transferred properly. Users should select power supply voltage (phase voltage or line voltage) based on ATS type. If choose phase voltage, connect the phase voltage of S1 and S2 (e.g. A phase) to normally close (Pin5) and normally open (Pin7) contact of auxiliary output 1; connect N phase of S1 and S2 to normally close (Pin8) and normally open (Pin10) contact of auxiliary output 2. And then connect the common output of auxiliary output 1 and auxiliary output 2 to ATS power supplies. Enter into the parameter setting interface, set the configurable output 1 as "ATS power L1" while set the configurable output 2 as "ATS power N". If the ATS power supplied by Line Voltage, same procedures as above but change phase N to phase voltage and the auxiliary output 2 should be configured according to the set. Wiring diagrams are shown as following:

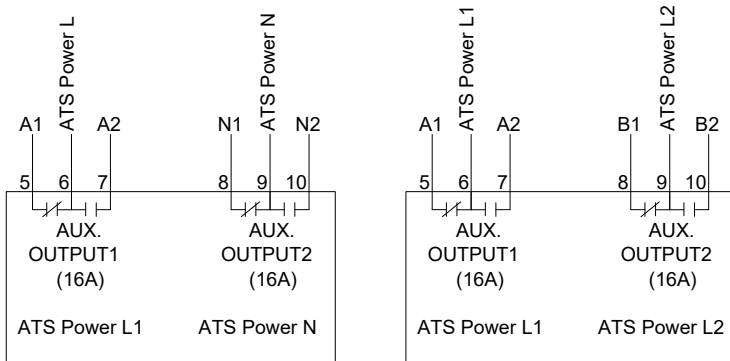

### Prompt status information



The following is the prompt information and status display, also including warning/alarm status, please refer to the catalog "**Warning and fault alarm**".

NO.	Item	Description
1	Please reset the alarm	When there is fault alarm occurs, the indication will be displayed when change the genset mode to Auto Mode manually. Show in status bar
2	S1 was already closed	After S1 was already closed, the indication will be displayed when "S2 close" button is pressed. Show in status bar
3	S2 was already closed	After S2 was already closed, the indication will be displayed when "S1 close" button is pressed. Show in status bar
4	Start Inhibit	Genset start Inhibit is active. Show in status bar
5	S1 Load Inhibit	S1 Load Inhibit input is active. Show in status bar
6	S2 Load Inhibit	S2 Load Inhibit input is active. Show in status bar
7	Remote Gen On Load	Remote start (on load) signal is active. Show in status bar
8	Remote Gen Off Load	Remote start (off load) signal is active. Show in status bar
9	Gen Start Mains NG	Start genset when mains is abnormal. Show in status bar
10	Cycle Gen Start Mode	Cycle Run Start Mode is active when "S1 Gens S2 Gens" system is active. Show in status bar
11	Balance Gen Hours Mode	Balance Run Start Mode is active when "S1 Gens S2 Gens" system is active. Show in status bar
12	Master-Slave Gen Start Mode	Master Run Start Mode is active when "S1 Gens S2 Gens" system is active. Show in status bar
13	Auto Mode	Current mode is Auto mode. Show in status bar
14	Manual Mode	Current mode is Manual mode. Show in status bar

### S1 Voltage status

No.	Item	Description
1	S1 Available	S1 Normal Delay.
2	S1 Unavailable	S1 Abnormal Delay.
3	S1 Volt Available	Power supply voltage is within the setting range.
4	S1 Blackout	Voltage is 0.
5	S1 Over Volt	Voltage is higher than the set value.

6	S1 Under Volt	Voltage has fallen below the set value.
7	S1 Over Freq	Frequency is higher than the set value.
8	S1 Under Freq	Frequency has fallen below the set value.
9	S1 Loss of Phase	Loss of any phase of A, B and C.
10	S1 Phase Seq Wrong	A-B-C phase sequence is wrong

## S2 Voltage status

No.	Item	Description
1	S2 Available	S2 Normal Delay.
2	S2 Unavailable	S2 Abnormal Delay.
3	S2 Volt Available	Power supply voltage is within the setting range.
4	S2 Blackout	Voltage is 0.
5	S2 Over Volt	Voltage is higher than the set value.
6	S2 Under Volt	Voltage has fallen below the set value.
7	S2 Over Freq	Frequency is higher than the set value.
8	S2 Under Freq	Frequency has fallen below the set value.
9	S2 Loss of Phase	Loss of any phase of A, B and C.
10	S2 Phase Seq Wrong	A-B-C phase sequence is wrong

## Genset status

No.	Item	Description
1	Genset Start Delay	Delay time before genset start
2	Genset Return Delay	Delay time before genset stop
3	Gen1 Cycle Run	S1 cycle run countdown will be terminated when cycle start is active.
4	Gen2 Cycle Run	S2 cycle run countdown will be terminated when cycle start is active.
5	S1 Genset Working	Active when system type is "S1 Gens S2 Gens".
6	S2 Genset Working	Active when system type is "S1 Gens S2 Gens".
7	Genset Working	Genset start signal output.
8	Genset Standby	There is no start genset signal output.

## Switch status

No.	Item	Description
1	Closing S1	S1 closing delay is in progress
2	Opening S1	S1 opening delay is in progress
3	Closing S2	S2 closing delay is in progress.
4	Opening S2	S2 opening delay is in progress.
5	Transfer Rest	Interval time between switch transfer
6	Closing S1 Again	When the S1 "Fail to open" condition occurs, it's the delay time before the close relay is active for the second time.
7	Opening S1 Again	When the S1 "Fail to close" condition occurs, it's the delay time before the open relay is active for the second time.
8	Closing S2 Again	When the S2 "Fail to open" condition occurs, it's the

		delay time before the close relay is active for the second time.
9	Opening S2 Again	When the S2 "Fail to close" condition occurs, it's the delay time before the open relay is active for the second time.
10	Waiting S1 PF	Before S1 is closed, it's the delay time to confirm "S1 PF Input" signal is active.
11	Waiting S2 PF	Before S2 is closed, it's the delay time to confirm "S2 PF Input" signal is active.
12	S1 On Load	S1 was already closed and S1 is taking load.
13	S2 On Load	S2 was already closed and S2 is taking load.
14	Offload	Switch was already opened and load disconnect.

## Warning and fault alarm

### ◆ Warnings



Notes: Warning is a non-serious failure state, which will not harm the gensets system for the time being. It only reminds operators to pay attention to the situation that does not meet the requirements and solve it in time to ensure the continuous operation of the system. When the warning occurs, the gensets does not stop. Once the fault is removed, the warning is automatically canceled.



Notes: Warning When a fault occurs, the warning indicator is always on, and the current fault interface displays a warning description, but it does not stop.

NO.	Item	Description
1	S1 Over Current Warn	When the S1 current has exceeded the pre-set value and the action select "Warn" without tripping, " <b>WARNING</b> " lights always on, displays " <b>S1 Over Current Warn</b> " on the current fault screen.
2	S2 Over Current Warn	When the S2 current has exceeded the pre-set value and the action select "Warn" without tripping, " <b>WARNING</b> " lights always on, displays " <b>S2 Over Current Warn</b> " on the current fault screen.
3	Forced Open Warn	When the input is active and the action select "Warn", " <b>WARNING</b> " lights always on, displays " <b>Forced Open Warn</b> " on the current fault screen.
4	Battery Over Volt	When the input is active and the action select "Warn", " <b>WARNING</b> " lights always on, displays " <b>Battery Over Volt</b> " on the current fault screen.
5	Battery Under Volt	When the battery voltage has fallen below the pre-set value, " <b>WARNING</b> " lights always on, displays " <b>Battery Under Volt</b> " on the current fault screen.

### ◆ fault alarm



Warning: After the fault alarm occurs, the system will be immediately trip. Only after troubleshooting, press  key to clear the alarm, can it be closing normally.



Notes: When a fault alarm occurs, the "**ALARM**" lights flicker and the current fault interface displays the alarm description and trips.

NO.	Item	Description
1	S1 Failed to Close	In Auto mode, S1 close failure is occurs. " <b>ALARM</b> " lights always on, displays " <b>S1 Failed to Close</b> " on the current fault screen.
2	S1 Failed to Open	In Auto mode, S1 open failure is occurs. " <b>ALARM</b> " lights always on, displays " <b>S1 Failed to Open</b> " on the current fault screen.
3	S2 Failed to Close	In Auto mode, S2 close failure is occurs. " <b>ALARM</b> " lights always on, displays " <b>S2 Failed to Close</b> " on the current fault screen.
4	S2 Failed to Open	In Auto mode, S2 open failure is occurs. " <b>ALARM</b> " lights always on, displays " <b>S2 Failed to Open</b> " on the current fault screen.
5	S1 Over Current Trip	When the S1 current has exceeded the pre-set value and the action select "Trip", Over current trip " <b>ALARM</b> " lights always on, displays " <b>S1 Over Current Trip</b> " on the current fault screen.
6	S2 Over Current Trip	When the S2 current has exceeded the pre-set value and the action select "Trip", Over current trip " <b>ALARM</b> " lights always on, displays " <b>S2 Over Current Trip</b> " on the current fault screen.
7	Forced Open Fault	When the input is active and the action select "Fault", it will initiate a fault alarm, " <b>ALARM</b> " lights always on, displays " <b>Forced Open Fault</b> " on the current fault screen.
8	S1 Genset Fault	If there is "S1 fail to start" failure occurs when "S1 Gens S2 Gens" system is selected, it will initiate a fault alarm. " <b>ALARM</b> " lights always on, displays " <b>S1 Genset Fault</b> " on the current fault screen.
9	S1 Genset Fault	If there is "S2 fail to start" failure occurs when "S1 Gens S2 Gens" system is selected, it will initiate a fault alarm. " <b>ALARM</b> " lights always on, displays " <b>S2 Genset Fault</b> " on the current fault screen.
10	Switch Trip Alarm	it will initiate a fault alarm. when the input is active. " <b>ALARM</b> " lights always on, displays " <b>Switch Trip Alarm</b> " on the current fault screen.



### Parameter setting



#### ◆ Enter the edition page





Please set the parameters according to below steps:

- 1) In the stop mode, please and simultaneously, then loose so that you can come to password interface, the default password is "07623".
- 2) Press and add number 1, press to reduce number 1, press to turn the digit into right, press to turn the digit into left, press once done. Then system comes into menu after confirmation of password setting. The screen will display

error if password is wrong. The correct password should be put after pressing any button.

3) Press  to turn the digit into upper position, press  to turn the digit into lower position, press  to get into parameters setting page.



4) Press  to shift up the parameters, press  to shift down the parameters, press  to get into parameter changing page.

5) Press  to add number 1, press  to reduce number 1, press  to turn the digit into right and press  to turn the digit into left, press  once done. If the parameters setting is in the valid setting range, then it can be saved, if not, it can't be saved.

6) Press  and  to save the parameters and exit from edition page.

7) Press  to revert back to last class if in any setting position.

 Revert back to default: put password "97011" when coming into parameters setting, then all the parameters can be set as defaults.

 Note: the data can't be saved if the user didn't press  and  to confirm the setting.

◆ **Parameter list.**

**1) Basic setting**

No	Parameter	Range (default)	Notes
0	Language	0-English 1- <b>Chinese</b>	Language option.
1	S1 Available Delay	1-3600S(10S)	The delay from S1 voltage abnormal to normal.
2	S1 Unavailable Delay	1-3600S(5S)	The delay from S1 voltage normal to abnormal.
3	S2 Available Delay	1-3600S(10S)	The delay from S2 voltage abnormal to normal.
4	S2 Unavailable Delay	1-3600S(5S)	The delay from S2 voltage normal to abnormal.
5	Master-Slave Set	0: <b>S1 Master</b> 1: S2 Master 2: No Master	Main and backup generator selection
6	System Type Set	0: <b>S1 Mains S2 Gen</b> 1: S1 Gen S2 Mains 2: S1 Mains S2 Mains 3: S1 Gen S2 Gen	Select the system type of S1, S2.
7	AC System	0: Single Phase,2-Wire 1: 2-Phase,3-Wire 2: 3-Phase,3-Wire 3: <b>3-Phase,4-Wire</b>	AC power supply mode for closing output.
8	PT Fitted	0: <b>Disable</b> 1: Enable	Voltage transformer function.
9	PT Primary	30-30000V (100V)	Primary voltage of voltage transformer
10	PT Secondary	30-1000V (100V)	Secondary voltage of voltage transformer

11	Rated Voltage	0-60000V ( <b>220V</b> )	AC system rated voltage value, used to calculate the alarm value.
12	Rated Frequency	10-75HZ ( <b>50HZ</b> )	AC system rated frequency value, used to calculate the alarm value.
13	Over Volt Set Value	0-200%( <b>120%</b> )	AC system voltage upper limit. If the value is greater than the upper limit, it will be abnormal. It will be disabled when the maximum value is 200.
14	Over Voltage Return	0-200%( <b>115%</b> )	AC system voltage upper limit return value. If the value is less than the return value, it is normal; if the maximum value is 200, it is disabled.
15	Under Voltage Set Value	0-200%( <b>80%</b> )	AC system voltage lower limit. If it is less than the lower limit, it will be abnormal. It will be disabled when the maximum value is 0.
16	Under Voltage Return Value	0-200%( <b>85%</b> )	AC system voltage lower limit return value. It is normal when it is greater than the return value, and it is disabled when the maximum value is 0.
17	Over Frequency Set Value	0-200%( <b>110%</b> )	Upper frequency limit. If the value is greater than the upper limit, it will be abnormal. It will be disabled when the maximum value is 200.
18	Over Frequency Return Value	0-200%( <b>104%</b> )	Frequency cap return value. Less than the return value is normal, and it is disabled when the maximum value is set to 200.
19	Under Frequency Set Value	0-200%( <b>90%</b> )	Lower frequency limit. If the value is less than the upper limit, it will be abnormal. It will be disabled when the minimum value is set to 0.
20	Under Frequency Return Value	0-200%( <b>96%</b> )	Frequency lower limit return value. It is normal when it is greater than the return value. Disabled when the minimum value is set to 0.
21	Phase Sequence Wrong	<b>0: Disable</b> 1: Enable	Phase sequence detection.

## 2) Switch setting

NO	Parameter	Range( <b>default</b> )	Notes
1	Close Time	1-20S( <b>5S</b> )	Pulse time of close relay
2	Open Time	1-20S( <b>5S</b> )	Pulse time of open relay
3	Transfer Interval	0-9999( <b>1S</b> )	Interval time from S1 switch open to S2 switch close; or from S2 switch open to S1 switch close.
4	Again Close Delay	0-20S( <b>1S</b> )	When the breaker fail to open for the first time, then the module will close for the second time and the Again Close Delay begins, after the



			delay has expired, if still failed to open for the second time, the module will send out fail to open alarm.
5	Again Open Delay	0-20S(1S)	When the breaker fail to close for the first time, then the module will open for the second time and the Again Open Delay begins, after the delay has expired, if still failed to close for the second time, the module will send out fail to close alarm.
6	Switch Type	0: <b>CB/CC</b> 1: PC Three-stage 2: PC Two-stage	0: Use S1 Open and S2 Open to control) 1: PC switch with OFF position, use S1 Open to control 2: PC switch without OFF position
7	Forced Open Action	0: <b>Warn Alarm</b> 1: Fault Alarm	Forced breaking function
8	Continuously Close	0: <b>Disable</b> 1: Enable	If "Enable" is selected, "Close Time" and "Open Time" are deactivated.
9	ATS Power Type	0: DC Power; 1: <b>AC Power</b>	Switch power supply type selection.
10	ATS Power Low Point	0-100% (70%)	Lower limit voltage of switch power; The switch can not transfer when the value has fallen below the set value.
11	ATS Power High Point	0-200% (130%)	Upper limit voltage of switch power; The switch can not transfer when the value has exceeded the set value.

### 3)Generator setting

NO	Parameter	Range (defaults)	Notes
1	Gen Start Delay	0-9999S(1S)	When the genset is ready to start, start delay begins, after the start delay has expired, start signal will be initiated.
2	Gen Stop Delay	0-9999S(5S)	When the genset is ready to stop, stop delay begins, after the stop delay has expired, stop signal will be initiated.
3	Gen-Gen Start Mode	0: Cycles Gens 1: Master-Slave Gens 2: Balance Gens Hours	Generator start mode.
4	S1 Cycles Work Time	0-9999Min(720Min)	Gens cycle start S1 running time.
5	S2 Cycles Work Time	0-9999Min(720Min)	Gens cycle start S2 running time.
6	Genset Available Time	0-9999S(120S)	When the start signal is active, the start delay will be initiated. If the gen voltage lasts abnormal after the delay has expired, "Genset Fault" alarm will be initiated.
7	Battery Under	0-100V(10V)	"Battery Under Volts" alarm will be initiated if the

	Volt Set Value		battery voltage has fallen below the set value.
8	Battery Under Volt Return Value	0-100V( <b>10.5V</b> )	"Battery Under Volts" alarm will be removed if the battery voltage has exceeded the set value.
9	Battery Over Volt Set Value	0-100V( <b>30V</b> )	"Battery Over Volts" alarm will be initiated if the battery voltage has exceeded the set value.
10	Battery Over Volt Return Value	0-100V( <b>29.5V</b> )	"Battery Over Volts" alarm will be removed if the battery voltage has fallen below the set value.

#### 4) Load setting (Only for ATS520I and ATS520IR)

NO	Parameter	Range(defaults)	Notes
1	Current CT Enable	0: Disable 1: <b>Enable</b>	Load current monitoring function.
2	CT Primary	5-6000A( <b>500A</b> )	Used for setting genset CT primary current, secondary rated current 5A.
3	CT start value	100-300mA( <b>300mA</b> )	Secondary current start controller minimum.
4	S1 Full Load Rating	5-6000A( <b>500A</b> )	The current of S1 taking full load.
5	S2 Full Load Rating	5-6000A( <b>500A</b> )	The current of S2 taking full load.
6	Over Current	0-200%( <b>120%</b> )	Over current set value.
7	Over Current Action	0: <b>Warn</b> 1: Trip	Over current protection action selection.
8	Over phase current delay	0-3600( <b>10S</b> )	When this parameter is set to 0, the over current delay is the inverse time; if not, the over current delay is the time set for this parameter.
9	Over current 【inverse time】	1-36( <b>36</b> )	This option will not take effect until the [19-Over phase current delay] is set to 0. The overcurrent delay is inverse time, and the formula is $T=t/((IA/IT) - 1) ^2$ .

#### 5) Input/Output setting

No	Parameter	Range(defaults)	Notes
1	Aux. Input digital 1	0-25( <b>1</b> )	<b>0: Disable:</b> Disable this digital function <b>1: Forced Open:</b> No matter the genset is in manual mode or Auto mode, when the input is active, this will force the breaker to transfer the ATS to OFF position. "No Breaking" ATS is unavailable. <b>2: Remote Start on Load:</b> When the mains power is normal, the generator set will start to output and the generator will close. <b>3: Remote Start Off Load:</b> When the mains power is normal, the generator set starts to output and the power generation is not closed. <b>4: Gen1 Fault Input:</b> When the unit is turned on cyclically, the unit fails and cannot be
3	Aux. Input digital 2	0-25( <b>7</b> )	
5	Aux. Input digital 3	0-25( <b>0</b> )	
7	Aux. Input digital 4	0-25( <b>0</b> )	

			<p>started.</p> <p><b>5: Gen2 Fault Input:</b> When the unit is turned on cyclically, the unit fails and cannot be started.</p> <p><b>6: Start Inhibit Input:</b> It is forbidden to output the start signal of the generator set. In the automatic mode, the output signal of the generator set is disconnected after the shutdown delay has expired. In the manual mode, if the device is turned on, it needs to be stopped manually.</p> <p><b>7: Breaker Trip Input:</b> Switch trip fault input.</p> <p><b>8: S1 Close Inhibit:</b> S1 closing is prohibited. In manual mode, manual closing is prohibited. If it is closed, it needs to be opened manually. In automatic mode, if it is closed, the load is disconnected or S2 is loaded.</p> <p><b>9: S2 Close Inhibit:</b> S2 closing is prohibited. In manual mode, manual closing is prohibited. If it is closed, it needs to be opened manually. In automatic mode, if it is closed, the load is disconnected or S1 is loaded.</p> <p><b>10: S1 Breaker PF Input:</b> S1 is ready to close. Wait for the active power input of S1 to be valid before closing S1.</p> <p><b>11: S2 Breaker PF Input:</b> S2 is ready to close. Wait for the active power input of S2 to be valid before closing S2.</p> <p><b>12: S1 O/C Key:</b> Simulate the panel S1 O/C button to control the S1 close/open. Self-reset button is recommended.</p> <p><b>13: S2 O/C Key:</b> Simulate the panel S2 O/C button to control the S2 close/open. Self-reset button is recommended.</p> <p><b>14: Alarm Reset:</b> Reset the current alarm.</p> <p><b>15: Alarm Mute:</b> Alarm output can be stopped.</p> <p><b>16: S1 Master Input:</b> Force S1 to be active.</p> <p><b>17: S2 Master Input:</b> Force S2 to be active.</p> <p><b>18: Forced Manual Mode:</b> Set the controller in Manual mode compulsively.</p> <p><b>19: Forced Auto Mode:</b> Set the controller in Auto mode compulsively.</p> <p><b>20: Reserved</b></p> <p><b>21: Reserved</b></p> <p><b>22: Reserved</b></p> <p><b>23: Reserved</b></p> <p><b>24: Reserved</b></p>
2	Aux. Input 1 Active Type	<b>0: Closed to active</b> 1: Open to active	Set the state when the switch value is valid
4	Aux. Input 2	<b>0: Closed to</b>	

	Active Type	<b>active</b> 1: Open to active	
6	Aux. Input 3 Active Type	<b>0: Closed to active</b> 1: Open to active	
8	Aux. Input 4 Active Type	<b>0: Closed to active</b> 1: Open to active	
9	Aux. Output Relay 1	0-60( <b>24ATS Power L1</b> )	<b>0: Disable:</b> Disable this relay function. <b>1: Common Alarm:</b> Output when the unit has any alarm, until the alarm is reset. <b>2: Common Fault Alarm:</b> Output when the unit has any fault alarm, the controller will open until the alarm resets. <b>3: Common Warn Alarm:</b> It is output when the unit has any warning alarm, until the alarm is reset. <b>4: Transition Fault:</b> It includes S1 Fail to Close alarm, S1 Fail to Open alarm, S2 Fail to Close alarm, S2 Fail to Open alarm. <b>5: Genset Start Delay:</b> Genset start-up delay output. <b>6: Genset Stop Delay:</b> Genset shutdown delay output. <b>7: S1 Available:</b> Output when S1 power is normal. <b>8: S1 Unavailable:</b> Output when S1 power supply is abnormal. <b>9: S2 Available:</b> Output when S2 power is normal. <b>10: S2 Unavailable:</b> Output when S1 power supply is abnormal. <b>11: S1 Over Current:</b> When S1 is under load, the load is over-current output. <b>12: S2 Over Current:</b> When S1 is under load, the load is over-current output. <b>13: Manual Mode:</b> Output when the genset is in Manual mode. <b>14: Auto Mode:</b> Output when the genset is in Auto mode. <b>15: Genset Start Output:</b> Control the genset to start. <b>16: S1 Close Control:</b> Control the S1 switch to close. <b>17: S1 Open Control:</b> Control the S1 switch to open. If PC Three-stage is selected, it also Control the S2 switch to open. <b>18: S2 Close Control:</b> Control the S2 switch to close. <b>19: S2 Open Control:</b> Control the S2 switch to open.
11	Aux. Output Relay 2	0-60( <b>27 ATS Power N</b> )	
13	Aux. Output Relay 3	0-60( <b>17 S1 Open Control</b> )	
15	Aux. Output Relay 4	0-60( <b>19 S2 Open Control</b> )	
17	Aux. Output Relay 5	0-60( <b>0 Disable</b> )	
19	Aux. Output Relay 6	0-60( <b>15Genset Start Output</b> )	

			<p><b>20: Breaker1 On Feedback:</b> The close status of S1 switch.</p> <p><b>21: Breaker2 On Feedback:</b> The close status of S2 switch.</p> <p><b>22: S1 Genset Start:</b> When the system type is "S1 Gen S2 Gen", it controls the S1 genset start.</p> <p><b>23: S2 Genset Start:</b> When the system type is "S1 Gen S2 Gen", it controls the S2 genset start.</p> <p><b>24: ATS Power L1:</b> 24-27 ATS power status output. Refer to the related description of ATS power supply "<b>Switch operation and ATS power control</b> in the catalog".</p> <p><b>25: ATS Power L2</b></p> <p><b>26: ATS Power L3</b></p> <p><b>27: ATS Power N</b></p> <p><b>28: S1 Blackout:</b> 28-33 S1 power status output.</p> <p><b>29: S1 Over Volt</b></p> <p><b>30: S1 Under Volt</b></p> <p><b>31: S1 Over Freq</b></p> <p><b>32: S1 Under Freq</b></p> <p><b>33: S1 Loss Of Phase</b></p> <p><b>34: S1 Phase Seq Wrong</b></p> <p><b>35: S2 Blackout:</b> 35-41 S2 power status output.</p> <p><b>36: S2 Over Volt</b></p> <p><b>37: S2 Under Volt</b></p> <p><b>38: S2 Over Freq</b></p> <p><b>39: S2 Under Freq</b></p> <p><b>40: S2 Loss Of Phase</b></p> <p><b>41: S2 Phase Seq Wrong</b></p> <p><b>42: Battery Under Volt:</b> Output when battery is under voltage.</p> <p><b>43: Battery Over Volt:</b> Output when battery is over voltage.</p> <p><b>44-60: Reserved</b></p>
10	Aux. Output 1 Active Type	<b>0: Normally open</b> 1: Normally close	Set the state when the relay output is active
12	Aux. Output 2 Active Type	<b>0: Normally open</b> 1: Normally close	
14	Aux. Output 3 Active Type	<b>0: Normally open</b> 1: Normally close	
16	Aux. Output 4 Active Type	<b>0: Normally open</b> 1: Normally close	
18	Aux. Output 5 Active Type	<b>0: Normally open</b> 1: Normally close	
20	Aux. Output 6 Active Type	<b>0: Normally open</b> 1: Normally close	

### 6) Working and maintenance setting

No	Parameter	Range(defaults)	Notes
1	Working plan format	<b>Disable</b> Every month Every week	This mode must be under auto mode. Working plan is disabled once setting as disable. The working plan will be executed according the chosen date when setting as every month. The working plan will be executed according the chosen date when setting as every week.
2	Maintenance date per month	From 1 <sup>st</sup> to 31 <sup>st</sup> <b>Default: the first day</b>	The date chosen for every month.
3	Maintenance date per week	Monday to Sunday <b>Default: Sunday</b>	The date chosen for every week.
4	Maintenance with load or not	<b>Disabled</b> /with load	To choose if the genset starts with load or not.
5	Maintenance start time	00:00-23:59( <b>00:00</b> )	Maintenance start time setting.
6	Maintenance running time	1-120m( <b>5m</b> )	Maintenance running time setting.

### 7) Display setting

No	Parameter	Range(default)	Notes
1	Start screen display	0-20.0s ( <b>5.0s</b> )	Start screen display time,0: No-display.
2	Saving mode	5.0-6000.0s ( <b>600.0s</b> )	LCD light will be closed automatically without any button pressed after delay. If setting as 6000.0s, back light always lighted.
3	Homing display	5.0-600.0s ( <b>600.0s</b> )	The time when the page reverts back to the home page, If setting as 600.0s: disabled.
4	LOGO delay display under standby	5.0-6000.0( <b>6000.0s</b> )	Start screen will be opened without any button pressed after delay, If setting as 6000.0s: disabled.

### 8) Other setting

No	Parameter	Range(default)	Notes
1	Primary Modes	0: Manual 1: Auto <b>2: Previous Mode</b>	The primary modes on power, easy for user operation.
2	Controller ID	1-255( <b>16</b> )	The IP built by controller and PC.
3	User password	00000-65535( <b>07623</b> )	Change the password.
4	RS485 baud rate	0-4800 <b>1-9600</b> 2-19200	RS485 communication baud rate.
5	Stop Bit	1 <b>2</b>	2 stop bits or 1 stop bit can be set.

6	Date/Time	2016/01/01-2099/12/31	Permanent calendar inside, please correct the date timely.
7	Current time	00:00:00-23:59:59	Permanent calendar inside, please correct the time timely.

### Fault finding

Symptoms	Possible Solutions
Controller no response with power	Check DC voltage. Check DC fuse. Check AC Power supply.
Genset Start Abnormal	Check the system type setting; Check the output port function type and output settings; Check various start / stop function settings
Genset running while ATS not transfer	Check switch Check the connection between the controller and the switch; Check whether the switch type setting is consistent with the switch; Check ATS power settings and wiring
Auxiliary Output Error	Check auxiliary output connections, pay attention to normally open contact and normally close contact. Check the output settings in parameters settings.
Auxiliary Input Abnormal	Check whether the programmable input port is reliably grounded when the input is valid, and it should be left floating when the input is invalid (Note: If the input port is connected to an excessively high voltage, it may burn the input port); Input port setting function and input valid type in detection parameter setting
USB communication is abnormal	Check the USB connection. Check whether the USB port of the computer is normal. Check whether the USB driver is installed. Check whether the controller is normally powered on.
RS485 cannot communicate normally	Check the connection. Check if the communication ID number setting is correct. Check if the A and B lines of RS485 are reversed. Check if the RS485 communication line driver is installed or not. Check if the communication port of the PC is damaged. Add a 120 Ω resistor between the AB of the controller RS485.